

Operating Instructions Timer Remote Controller

Model No. **CZ-RTC4**

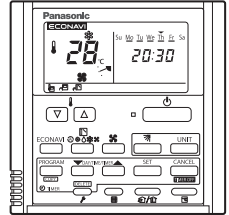

Installation Instructions
Separately Attached.

ENGLISH

Before operating the unit, read these operating instructions thoroughly and keep them for future reference.



Panasonic Corporation
1006 Kadoma, Kadoma City, Osaka, Japan

Panasonic Corporation
<http://www.panasonic.com>

CV6233312187

CONTENTS

Thank you for purchasing the Panasonic timer remote controller.

- Read the Operating Instructions carefully for safe use. This manual describes the Operating Instructions of the timer remote controller. Read this manual as well as operating instructions supplied with indoor units and outdoor units.
- **Be sure to read the “Safety Precautions” (P.3, 4) before using.**
- Keep this manual with operating instructions supplied with indoor units and outdoor units in a safe place.
- Be sure to keep this manual in a place easily accessible by users. In the case of user change, be sure to give this manual to the new user.

NOTICE

The English text is the original instructions. Other languages are translation of the original instructions.

	Page	
<ul style="list-style-type: none"> ● Safety Precautions.....3 ● Part Names5 <ul style="list-style-type: none"> • Control panel5 • Screen display6 		Preparations
<ul style="list-style-type: none"> ● Basic Operations.....7 <ul style="list-style-type: none"> • How to Operate.....7 • Setting the Present Time9 ● Weekly Program Function.....10 <ul style="list-style-type: none"> • Checking the Weekly Timer10 • Changing the Program Timer.....11 • Deleting the Program Timer.....13 • Invalidating the Program Timer.....14 • Duplicating the Program Timer15 • Before Asking Repare work16 		How to Use
<ul style="list-style-type: none"> ● Outing Function17 <ul style="list-style-type: none"> • Setting the Outing Function18 ● Sleeping Function.....19 ● ECONAVI Function.....22 <ul style="list-style-type: none"> • ON/OFF setting of ECONAVI function ...23 		Setting Change
<ul style="list-style-type: none"> ● Troubleshooting24 ● Specifications.....26 		When Necessary

Safety Precautions



WARNING

This symbol refers to a hazard or unsafe practice which can result in severe personal injury or death.



CAUTION

This symbol refers to a hazard or unsafe practice which can result in personal injury or product or property damage.



Matters to be observed



Prohibited matters



WARNING



Do not use this appliance in a potentially explosive atmosphere.



In case of malfunction of this appliance, do not repair by yourself. Contact the sales or service dealer for repair.



In case of emergency, remove the power plug from the socket or switch off the circuit breaker or the means by which the system is isolated from the mains power.



CAUTIONS



This appliance is intended to be used by expert or trained users in shops, in light industry and on farms, or for commercial use by lay persons.

This appliance can be used by children aged from 8 years and above and persons with reduced physical, sensory or mental capabilities or lack of experience and knowledge if they have been given supervision or instruction concerning use of the appliance in a safe way and understand the hazards involved.



- Do not operate with wet hands.
- Do not wash with water.

Safety Precautions

Note:

- This device complies with Part 15 of the FCC Rules. Operation is subject to the following two conditions: (1) This device may not cause harmful interference, and (2) this device must accept any interference received, including interference that may cause undesired operation.
- This equipment has been tested and found to comply with the limits for a Class B digital device, pursuant to Part 15 of the FCC Rules. These limits are designed to provide reasonable protection against harmful interference in a residential installation. This equipment generates, uses and can radiate radio frequency energy and, if not installed and used in accordance with the instructions, may cause harmful interference to radio communications. However, there is no guarantee that interference will not occur in a particular installation. If this equipment does cause harmful interference to radio or television reception, which can be determined by turning the equipment off and on, the user is encouraged to try to correct the interference by one or more of the following measures:
 - Reorient or relocate the receiving antenna.
 - Increase the separation between the equipment and receiver.
 - Connect the equipment into an outlet on a circuit different from that to which the receiver is connected.
 - Consult the dealer or an experienced radio/TV technician for help.
- FCC Caution: To assure continued compliance, follow the attached installation instructions. Any changes or modifications not expressly approved by the party responsible for compliance could void the user's authority to operate this equipment.

Part Names

Control panel

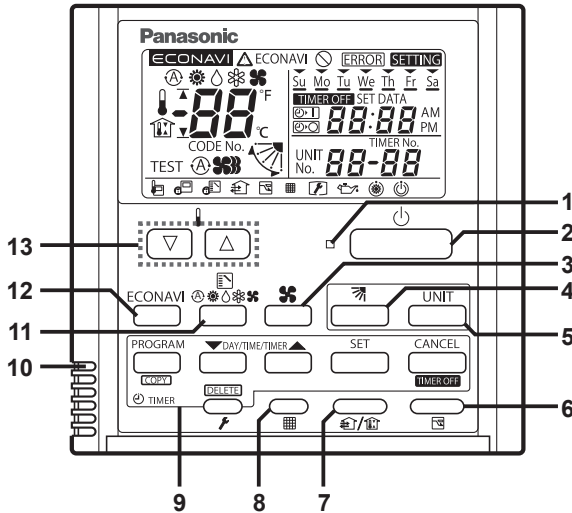

- 1 Operation indicator**
Illuminates during operation. Blinks during alarm.
- 2 Start/Stop button**
Starts/Stops operation.
- 3 Fan speed**
Changing the fan speed.
- 4 Swing/Air direction**
Use this button to set the auto swing or air direction to a specific angle.
- 5 Unit select**
When more than one indoor unit is operated by one remote control unit, this button is used to select a unit when adjusting the air direction.
- 6 Sleeping**
- 7 Ventilation**
Use this button when you installed a fan available in the market. Pressing this button turns on and off the fan. When turning off the air conditioner, the fan will be also turned off.
- 8 Filter reset**
Use this button to reset the filter sign. When  is displayed, press this button after cleaning the filter.
- 9 Timer setting buttons**
- 10 Remote control sensor**
Normally, the temperature sensor of the indoor unit is used to detect the temperature. However, it is also possible to detect the temperature around the remote control unit.
- 11 Mode select**
Pushing this button selects an operation mode.
- 12 ECONAVI**
Use this button to turn on/off the ECONAVI Function.
- 13 Temperature setting buttons**
Changing the temperature setting.

Part Names

Screen display

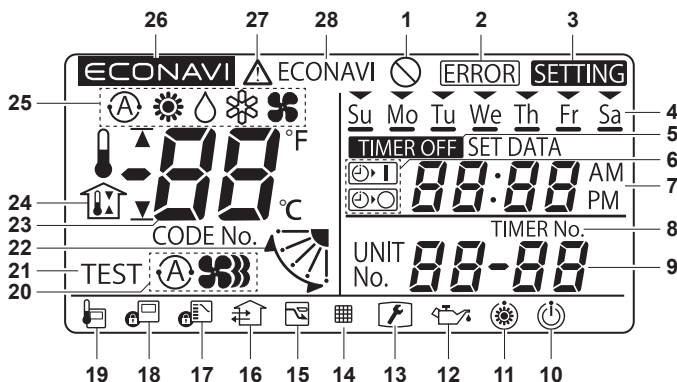





- 1 Displayed if the selected feature was disabled during installation.
- 2 Displayed when a mistake is made during timer setting.
- 3 Appears when the timer program is being set.
- 4 Indicates today's day of the week.
- 5 Displayed when the timer has been turned OFF.
- 6 Timer program indication
 ☑: The indoor unit starts operation at the programmed time.
 ☒: The indoor unit stops operation at the programmed time.
- 7 Displays the present time on a 24-hour clock. Also, displays settings in the various setting modes.
- 8 Appears when the time program is being set.
- 9 Indicates the unit No. of the selected indoor unit.
- 10 Appears during the peak cut mode (Demand) if an electric heat pump (EHP) air conditioner is used or during standby if a gas heat pump (GHP) air conditioner is used.
- 11 Appears when the fan of the indoor unit is stopped or in low fan speed.
- 12 The engine oil needs to be replaced. (Only when using a gas heat pump air conditioner.)
- 13 Appears when the maintenance function (monitoring sensor temperatures) is activated.
- 14 The indoor unit filter needs to be cleaned.
- 15 Appears during the sleeping function.
- 16 Appears when a fan available in the market is installed and is operating.
- 17 Switching operation modes is prohibited. (Switching to Auto mode is also prohibited.)
- 18 Remote control operation is restricted by a central control device.
- 19 Appears when the remote control sensor is used.
- 20 The selected fan mode is displayed.
 (AUTO Ⓐ / HEAT ☀ / DRY ◊ / COOL ❄ / FAN 🌀)
- 21 Appears while in test operation.
- 22 Indicates the flap position.
- 23 Indicates the set temperature.
- 24 Appears during the outing function.
- 25 Displays the selected operation mode.
 (AUTO Ⓐ / HEAT ☀ / DRY ◊ / COOL ❄ / FAN 🌀)
- 26 Appears when ECONAVI is being set to ON.
- 27 When inspection is required.
- 28 Appears with displaying 27 if there is a problem on ECONAVI.

Basic Operations

How to Operate

Turn on the indoor unit before operation. See operating instructions of the indoor unit.

Start/Stop operation / Operation mode

1. Press [Start/Stop] to start operation.
2. Press the mode select button to select the mode among AUTO , HEAT , DRY , COOL  and FAN .

* Auto: The mode is automatically switched to Cool or Heat to achieve the set temperature.

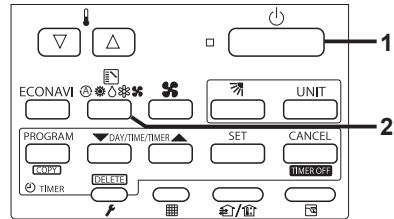

Set temperature

Press [∇/Δ] to set the desired temperature.

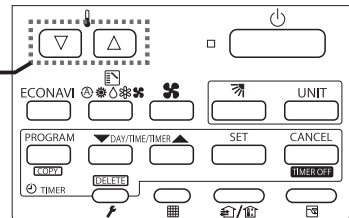

Cannot be set in Fan mode.

Temperature



Fan speed

Press the fan speed button to set the fan speed.

 : Automatically switches the fan speed.

: Low

: Medium

: High

Fan speed

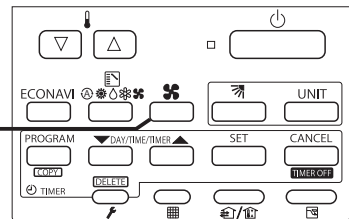



Flap

Press the flap button to adjust the flap position.

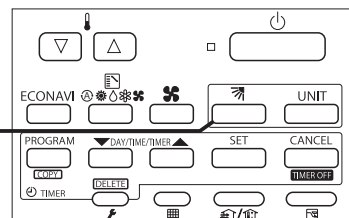
Flap



Note

- If the heating performance is insufficient in Low  fan speed, change the fan speed to Medium  or High .
- The temperature range that can be set varies depending on the model.
- Temperature sensor detects temperature in the vicinity of the air inlet of the indoor unit. The detected temperature slightly differs from the room temperature depending on the installation condition. The set temperature is a guideline of room temperature.

Basic Operations

Setting the Present Time

- 1 Press and hold [SET] for more than 2 seconds to enter the present day and time setting mode.**

Once you enter the setting mode, “SETTING”, “▼”(day) and “time” flash.

- 2 Set “▼” to today’s day of the week.**

Press [▲] to move “▼” (flashing on the display) in the order of: Su → Mo → Tu →
Press [▼] to move it in the order of: Su → Sa → Fr →
Press [SET] to store.

- 3 Press [▼/▲] to change the present “hour” in the range of 0 to 23*1.**

Set the present hour and press [SET].
The “hour” digits light up, and the “minute” digits start flashing.

*1 If the clock uses the 12 hours AM/PM setting, the hour is displayed in the range of AM 1 to 12 / PM 1 to 12.

- 4 Press [▼/▲] to change the present “minute” in the range of 0 to 59.**

Set the present minute and press [SET]. The day and time are set and the unit finishes the setting mode.

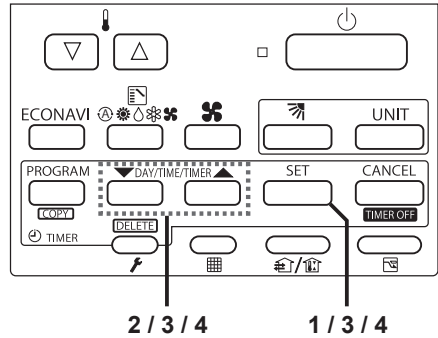

Note

- If the present time is invalid, “- - : - -” is displayed. If the power failure occurs, check if the set data of day and time are valid.

Weekly Program Function

Checking the Weekly Timer

- Set the weekly program assigning a given timer to each day of the week. Maximum of 6 programs a day and 42 programs a week can be set. Select the day and the TIMER number you want to program.

1 Press [PROGRAM] to enter the program confirmation mode “CH” and start setting.

Once you enter the program confirmation mode, the present day is indicated as TIMER No. “1”.

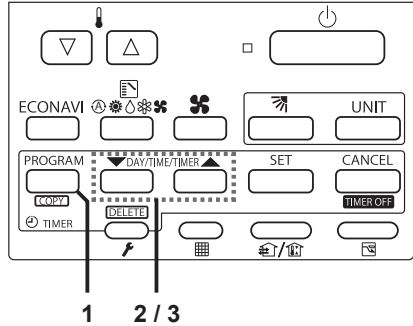

2 Select the day.

Press [▼/▲] to move the “▼” horizontally on the day to select.

Press [▲] to move “▼” (flashing on the display) in the order of: Su → Mo → Tu...

Press [▼] to move it in the order of : Su → Sa → Fr...

“-- : --” is displayed when the program is not set.

Press [SET] to fix the day.

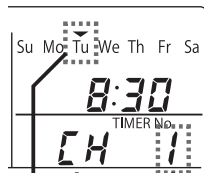

3 Select a Timer number.

Press [▼/▲] to select a TIMER No. from 1 to 6.

Press [▲] to move up from 1.

Press [▼] to move down from 6.

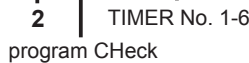

Weekly Program Function

Changing the Program Timer

To set the weekly program, follow the steps.

- 1 Select the program you want to set in the program confirmation mode, and press [SET]. This enters the setting mode of the program currently displayed.**

* In the program setting mode, [SETTING], "hour", "minute" and "item" flash on the display.

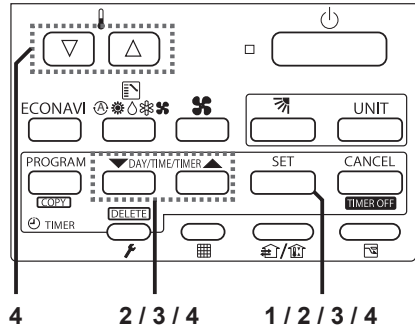

- 2 Set the "hour". (Program step 1)**

Press [▼/▲] to set the "hour". Confirm the "hour" and press [SET]. This enters the program changing mode **P2** (setting of the "minute").

- 3 Set the "minute". (Program step 2)**

Press [▼/▲] to set the "minute". Confirm the "minute" and press [SET]. The unit enters **P3** (the program pattern selection mode).

Program step1

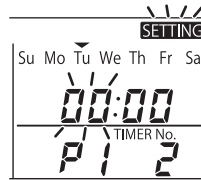

Program step2

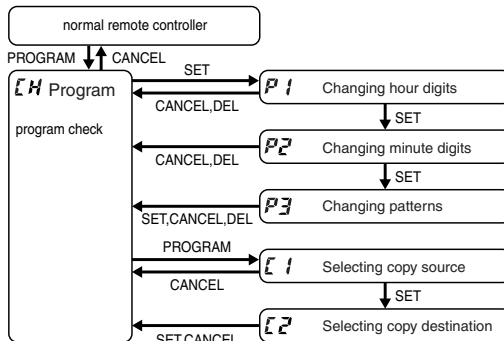
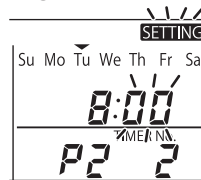

4 Set the program pattern. (Program step 3)

There are 4 program patterns.

Pressing [▼/▲] repeats the following display patterns.

Pattern 1 (Default display)

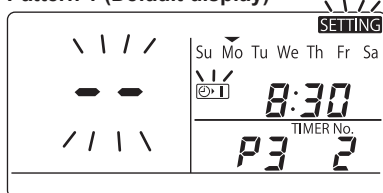

The indoor unit starts operation at the programmed time.

Pattern 2

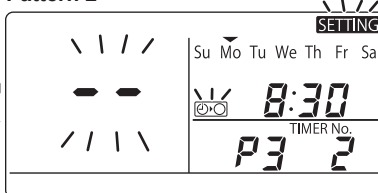

The indoor unit stops operation at the programmed time.

Pattern 4

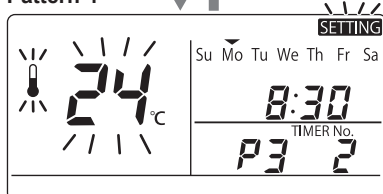

The indoor unit starts operation at the programmed time and changes the temperature settings.

Pattern 3

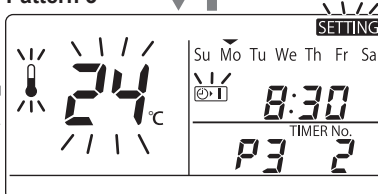

The indoor unit changes the temperature setting at the programmed time.

For Pattern 3 and Pattern 4: Press [▼/▲] to change the temperature setting.

5 Select the program pattern and press [SET].

The program timer setting is confirmed and the unit enters the confirmation mode **CH**.

Note

- If you press [CANCEL] during the setting, it returns to the program confirmation mode.
- If there is no operation made for 10 minutes during the setting, it returns to the normal mode.
In this case, all the settings in progress will be invalid.

Weekly Program Function

Deleting the Program Timer

To delete the program timer setting, follow the steps below.

- 1** Press **[PROGRAM]** to enter the program confirmation mode.
- 2** Press **[▼/▲]** to select the day of the program you want to delete.
Press **[SET]** to fix the day.
- 3** Press **[▼/▲]** to select a **TIMER No.** (from 1 to 6).
- 4** Press **[SET]** to display the program setting mode **P 1**.
- 5** Press **[DELETE]** to delete the program.

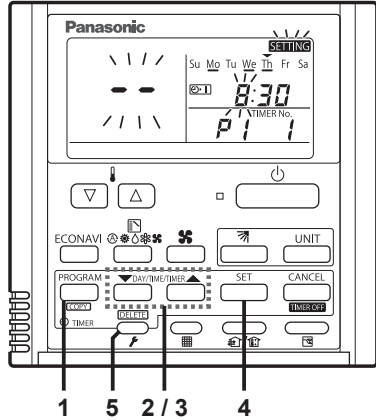

Note

- After deleting, the unit returns to the program confirmation mode **PH**.
- If you press **[CANCEL]** during the setting, the unit returns to the program confirmation mode.
- If there is no operation made for 10 minutes during the setting, the unit returns to the normal mode.

Weekly Program Function

Invalidating the Program Timer

If you want to stopping the program operation for more than 1 week, you can invalidate all the timer settings.

Once the timer settings are invalidated, the program will not be operated until the invalidation is cancelled.

How to invalidate the program timer

1. Press and hold [CANCEL]([TIMER OFF]) for more than 2 seconds.
[TIMER OFF] is displayed and the programs will be invalidated from the next one.

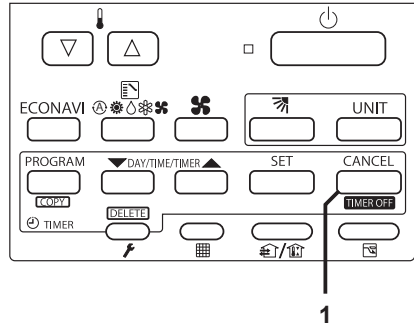

How to cancel the program timer invalidation

1. Press and hold [CANCEL]([TIMER OFF]) for more than 2 seconds.
[TIMER OFF] disappears and the programs will be validated from the next one.

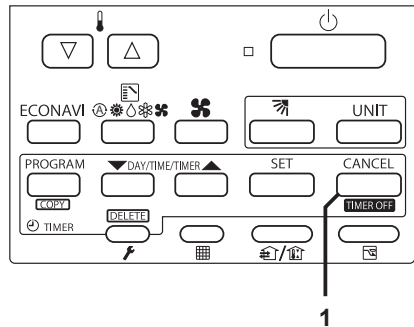

■ If Power Failure Occurred

If the power recovers in a short time period, the program after the recovered time will be valid.

If more than one hour has passed for power return after power failure, the present time information will be lost. In this case, the program will not be operated.

Weekly Program Function

Duplicating the Program Timer

You can duplicate the preset program by day.

■ Select the copy source.

- 1 If [PROGRAM]([COPY]) is pressed in program checking mode $\overline{[H]}$, it enters the copy mode (Selecting the copy source $\overline{[1]}$) of the program timer.

While in the copy mode of the program timer, [SETTING] and \blacktriangledown (day) of the copy source flash on the display.

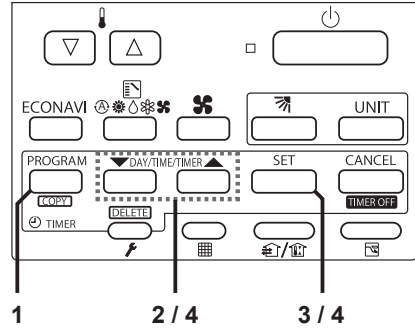

- 2 Press [\blacktriangledown / \blacktriangle] to select the day of the copy source.

Select the copy destination.

- 3 If [SET] is pressed in the mode of selecting the copy source $\overline{[1]}$, it enters the copy mode (Selecting the copy destination $\overline{[2]}$) of the program timer.

- 4 Press [\blacktriangledown / \blacktriangle] to select the day of the copy destination. Then, press [SET] to complete copying and return to the program checking mode.

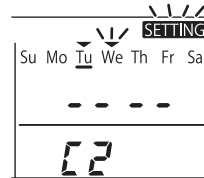
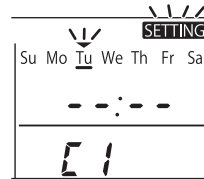

Note

The program will be overwritten if the preprogrammed day is selected as a copy source.

Weekly Program Function

Before Asking Repair Work

Before asking repair work, please check the following.

Trouble	Possible Cause/Remedy
"ERROR" is displayed when the minute digits are entered.	If there is another TIMER No. which has the program of the same time and same day, you cannot overlap the setting.
The set data is not stored.	The stored programs are automatically sorted by the time. Check if the data is stored in the other TIMER No.
Program does not function.	Check if the time indication is not "-- : --". When the time is invalid, the program is also invalid.
	Check the remote controller prohibition inside. In that case, the program is invalid.

Outing Function

Outing function is a function that prevents the room temperature from increasing too much (or decreasing too much) when no one is in the room. An air conditioner works automatically if this function is set effective.

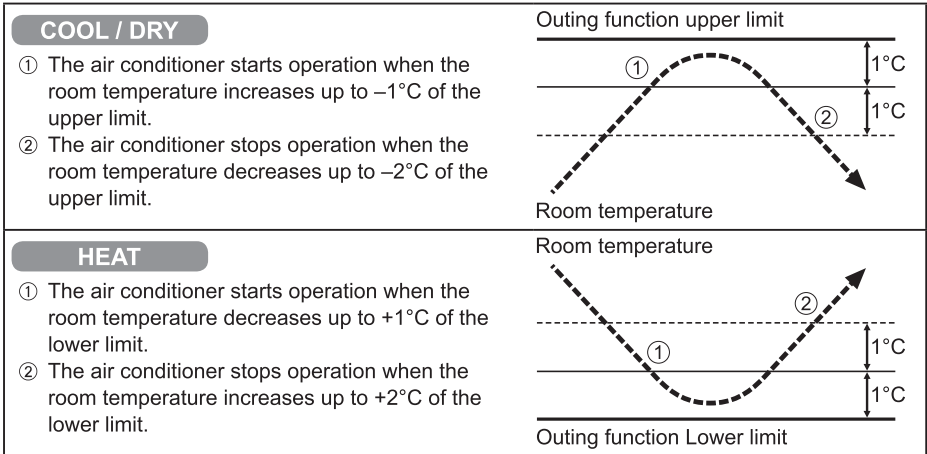

General Performance of the Outing Function



[Precautions]

- The outing control only starts/stops the air conditioner. It does not change the operation mode/temperature setting. Therefore, the operation mode/temperature needs to be set beforehand so that the outing function turns on the air conditioner with your desired operation mode/temperature setting.
 - If the room temperature rapidly changes, the room temperature may get over the upper or lower limit when the outing function is activated.
 - The outing function is invalid during FAN/AUTO operation mode.
 - The air conditioner's stop order (stated in ② / above) is valid only when the outing function is operated.
- If operated using other remote control unit (or a centralized control device such as a system control), the outing function does not work.

• Outing function indication

Outing function indication	Status
Off	The outing function is not set.
Flashing 	The outing function is now being set or under operation.
Lighting 	Although the outing function is set, it is not under operation.



Note

A remote controller may lose outing function operation information when it is cut for more than 24 hours during the outing function operation by electricity. It reverts from the blackout, and an air conditioner does not drive in outing function when operation is started. At this time, an air conditioner does not stop at outing function.

Outing Function

Setting the Outing Function

- 1 Press and hold [Ventilation] for more than 2 seconds to display the upper limit temperature setting screen.

[SETTING], ,  and the upper limit temperature start flashing.
(The default value of the upper limit temperature is 38 °C.)

- 2 Press [∇/Δ] to select the upper limit temperature, and press [SET] to fix the value. The lower limit temperature setting screen is displayed.

- 3 Press [∇/Δ] to select the lower limit temperature, and press [SET] to fix the value. The outing function setting is completed.

(The default value of the lower limit temperature is 10 °C.)

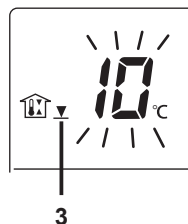
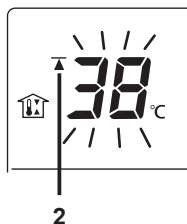
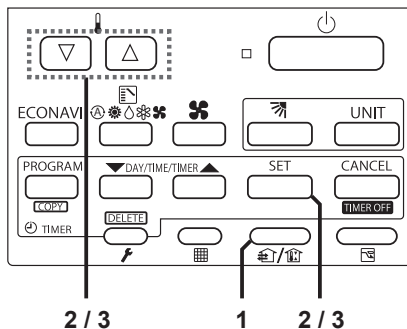

* The unit returns to the normal mode if [CANCEL] is pressed or there is no operation made for 3 minutes during the setting. In this case, all the settings in progress will be lost.

Canceling the outing function

1. Press and hold [Ventilation] for more than 2 seconds while the outing function is set.

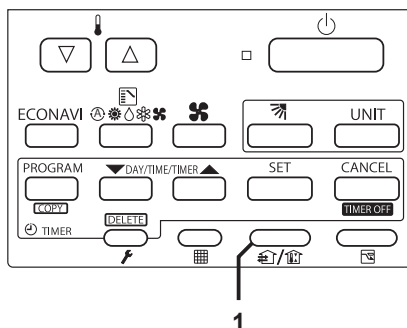

Sleeping Function

This function leads you to a comfortable sleep and changes the room temperature during your sleep.

- You can set the off timer every one hour from 1 to 10 hours.

■ Display of remote control unit (during the time setting)

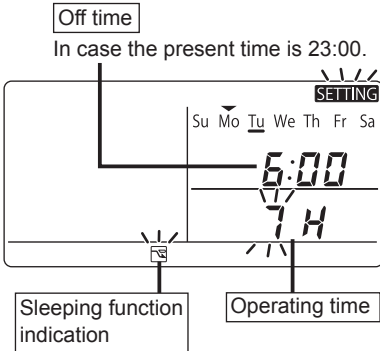

■ Display of remote control unit (during sleeping function setting)

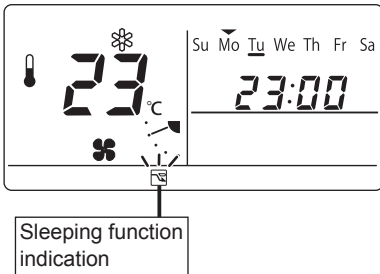

- * If no operation is made for 3 minutes, the time setting mode will be automatically finished.

Ex. In case of 7 hours timer

1 Press [Sleeping].

- Each time the button is pressed, the indication changes in the following order.

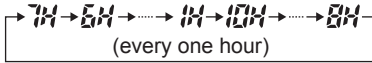

(Press [CANCEL] to stop the time setting.)

2 Press [SET].

- The sleeping operation starts.

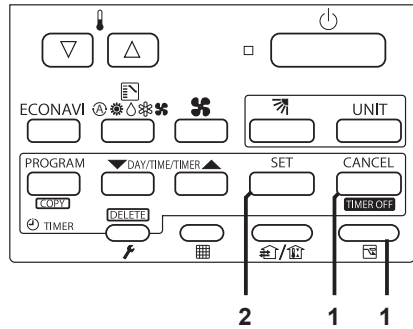

■ When the off time comes:

- The indoor unit stops.
 - * The temperature returns to the setting at the time when sleeping function operation started.

To cancel the sleeping function operation

1. Press [Sleeping].

- * The temperature setting remains at the time cancelled.

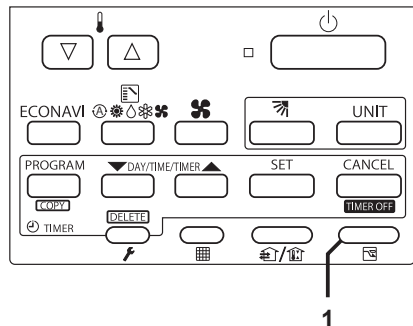

- The following buttons also cancel the sleeping function operation.

[Start/Stop] button

Stops the indoor unit after the sleeping function operation is cancelled.



[Mode select] button

Changes the operation mode after the sleeping function operation is cancelled.

■ If [Sleeping] button does not work.

Or, in the case of operation not being started even if [SET] is pressed.

Check the following table.

Item	Display of the remote control unit (Lighting/flashing indication)	Contents
1	 The Error indication flashes (for several seconds).	The clock is not set.
2	 "This function is not available" indication lights up (for several seconds).	When the operation mode is set to AUTO or FAN, this function is not available.
3	 Centralized control indication flashes (for several seconds).	The centralized control device is prohibited from starting/stopping the unit or changing the temperature setting.

The sleeping function operation will be cancelled in the following cases:

- 1: When the unit is operated to stop or change the temperature setting by the other remote control unit or centralized control device.
- 2: When the unit is operated to stop or change the temperature setting with the weekly program function / outing function.
- 3: When the centralized control unit is prohibited from stopping the unit or changing the temperature setting.

Note

Trouble	Possible Cause/Remedy
The temperature setting does not decrease (increase).	The temperature over the upper or lower limit or each operation mode cannot be set.
Operation under the sleeping function does not finish.	Note if you change the time after the sleeping function started. The operation does not finish until it reaches to the set starting time.

ECONAVI Function

This function is available by attaching an optional ECONAVI sensor.

The ECONAVI sensor detects human activity and conserves energy based on the activity level.

Overview of the ECONAVI function

High activity	<ul style="list-style-type: none"> • Cooling: Target temperature is the same as the set temperature. • Heating: Target temperature is 1 °C lower than the set temperature.
Low activity	<ul style="list-style-type: none"> • Cooling: Target temperature is 1 °C higher than the set temperature. • Heating: Target temperature is the same as the set temperature.
No one in the room	<p>No one in the room for 20 minutes</p> <ul style="list-style-type: none"> • Cooling: Target temperature is 2 °C higher than the set temperature. • Heating: Target temperature is 2 °C lower than the set temperature. <p>No one in the room for 3 hours</p> <ul style="list-style-type: none"> • Cooling: Cooling will stop and the unit will be in fan only mode. • Heating: Heating will stop and the unit will be in fan only mode.
<p>* When the sensor detects movements in the room which have been empty, it will resume operation to match with the activity level.</p>	

Note

- Even when target temperature is changed through the ECONAVI function, the set temperature shown in the remote controller does not change.
 - Even when Cooling/Heating is changed to Fan through the ECONAVI function, the operation mode shown in the remote controller will still be Cooling/Heating.
 - It is possible to choose from the following options for the operation to be performed after a lapse of 3 hours since the room has been empty.
 - Operates in the Fan mode only.
 - Stops and resumes operations after human movements are detected.
 - Stops and will not resume operations even after human movements are detected.
 - Continues to operate in the current mode.
- If you need to do so, please contact the dealer.

ECONAVI Function

ON/OFF setting of ECONAVI function

Using the remote controller, you can switch the ECONAVI function ON/OFF.

1 Press [ECONAVI] to ON the ECONAVI function.

* When ECONAVI is enabled, **ECONAVI** will appear.

2 Press [ECONAVI] to OFF.

* When the indoor unit is stopped, **ECONAVI** will disappear.

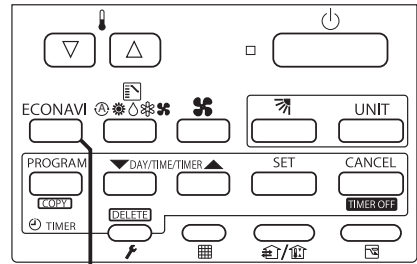

1 / 2

Note

- Turn the ECONAVI function OFF if:
 - You want to maintain the room temperature at a set temperature.
 - You want to keep air conditioner running while nobody is in a room.
 - The sensor fails.
 - Only infants, babies, or people only with disabilities are in the room.



WARNING

Do not use the ECONAVI function in a room with disabled persons or infants only. Due to their limited motions, the ECONAVI sensor may judge no person is present, causing the indoor unit to stop the operation.

Troubleshooting

If operation does not start by pressing [Start/Stop] button ...

Check the following before asking for repair.

Blackout?

- After recovery from blackout, press [Start/Stop] again.
- If operation does not start, turn off the circuit breaker and consult the dealer of purchase about the symptom and Model No.

Is the circuit breaker turned off?

- Turn it on and press [Start/Stop] again.
- If operation does not start, turn off the circuit breaker and consult the dealer of purchase about the symptom and Model No.

Is **SETTING blinking?**

- After blinking stops, press [Start/Stop] again.
- If operation does not start, turn off the circuit breaker and consult the dealer of purchase about the symptom and Model No.

Is  displayed?

- If any of the following alarm indications appears, stop operation once and restart approx. 1 minute later.
(Alarm indication, off)
[•E04 •E06 •P10 •P20 •H06]
- If the indication does not reappear, use the unit.
- If the indication reappears or an alarm indication other than the above (combination of numbers and characters such as E, F, H, L and P) appears, stop operation, turn off the circuit breaker and consult the dealer of purchase about alarm indication, Model No. and indoor unit No.

**Cannot stop the operation.
Or the unit starts to run automatically even if [Start/Stop] (Off) is pressed.**

- Check if the outing function is activated or not.

- Check control by central control device.

The remote controller screen displays a flashing “ ECONAVI”.

- Faulty sensor or incorrect installation. Turn OFF the ECONAVI function with the remote controller and contact the retailer or point of purchase with the Model No. and problem.

The remote controller screen does not display the .

- The indoor unit has stopped. Turn on the indoor unit.
- The unit is in Fan mode. The ECONAVI function does not operate in Fan mode.
- The ECONAVI function is set to OFF. Turn the ECONAVI function ON with the remote controller.
- The indoor unit may not support the ECONAVI function. If you turn the ECONAVI function ON with the remote control but there is no change, the indoor unit does not support the ECONAVI function. Please contact the dealer.

- If you need to contact for servicing, check the back cover of the operating instructions for indoor units or outdoor units.

Specifications

Model No.	CZ-RTC4	
Dimensions	(H) 120 mm x (W) 120 mm x (D) 20 + 4.75 mm	
Weight	160 g	
Temperature/ Humidity range	0 °C to 40 °C / 20 % to 80 % (no condensation) *Indoor use only.	
Power Source	DC16 V (supplied with indoor unit)	
Clock	Precision	± 30 seconds/month (at normal temperature 25 °C) *Adjust periodically.
	Holding time	24 hours (when fully charged) *Approx. 8 hours are required for full charge.
Number of connected indoor units	Up to 8 units	

Panasonic®

Operating Instructions High-spec Wired Remote Controller

Model No. **CZ-RTC3**

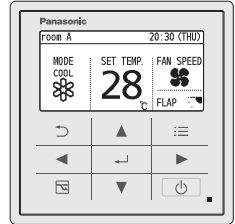

Installation Instructions
Separately Attached.

ENGLISH

Before operating the unit, read these operating instructions thoroughly and keep them for future reference.

CE Panasonic Corporation
1006 Kadoma, Kadoma City, Osaka, Japan

WEB-URL Panasonic Corporation
Website: <http://panasonic.net/>

CV6233312187

Part Names Control panel

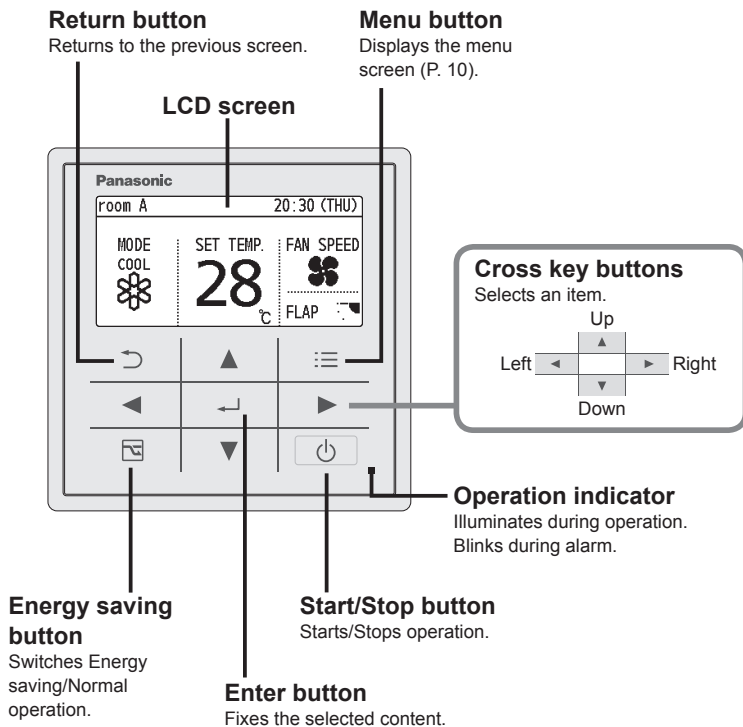

Note

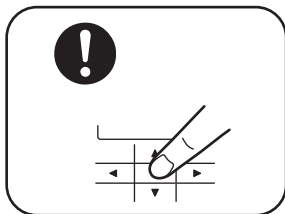

Press centre

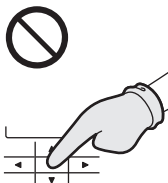

No glove



No pen

Safety Precautions



WARNING

This symbol refers to a hazard or unsafe practice which can result in severe personal injury or death.



CAUTION

This symbol refers to a hazard or unsafe practice which can result in personal injury or product or property damage.



Matters to be observed



Prohibited matters



WARNING



Do not use this appliance in a potentially explosive atmosphere.



In case of malfunction of this appliance, do not repair by yourself. Contact the sales or service dealer for repair.



In case of emergency, remove the power plug from the socket or switch off the circuit breaker or the means by which the system is isolated from the mains power.



CAUTIONS



This appliance is intended to be used by expert or trained users in shops, in light industry and on farms, or for commercial use by lay persons.

This appliance can be used by children aged from 8 years and above and persons with reduced physical, sensory or mental capabilities or lack of experience and knowledge if they have been given supervision or instruction concerning use of the appliance in a safe way and understand the hazards involved.



- Do not operate with wet hands.
- Do not wash with water.

Safety Precautions

Note:

- This device complies with Part 15 of the FCC Rules. Operation is subject to the following two conditions: (1) This device may not cause harmful interference, and (2) this device must accept any interference received, including interference that may cause undesired operation.
- This equipment has been tested and found to comply with the limits for a Class B digital device, pursuant to Part 15 of the FCC Rules. These limits are designed to provide reasonable protection against harmful interference in a residential installation. This equipment generates, uses and can radiate radio frequency energy and, if not installed and used in accordance with the instructions, may cause harmful interference to radio communications. However, there is no guarantee that interference will not occur in a particular installation. If this equipment does cause harmful interference to radio or television reception, which can be determined by turning the equipment off and on, the user is encouraged to try to correct the interference by one or more of the following measures:
 - Reorient or relocate the receiving antenna.
 - Increase the separation between the equipment and receiver.
 - Connect the equipment into an outlet on a circuit different from that to which the receiver is connected.
 - Consult the dealer or an experienced radio/TV technician for help.
- FCC Caution: To assure continued compliance, follow the attached installation instructions. Any changes or modifications not expressly approved by the party responsible for compliance could void the user's authority to operate this equipment.

Thank you for purchasing the Panasonic high-spec wired remote controller.

- Read the Operating Instructions carefully for safe use. This manual describes the Operating Instructions of the wired remote controller. Read this manual as well as operating instructions supplied with indoor units and outdoor units.
- Be sure to read the “Safety Precautions” (P.3, 4) before using.
- Keep this manual with operating instructions supplied with indoor units and outdoor units in a safe place.
- Be sure to keep this manual in a place easily accessible by users. In the case of user change, be sure to give this manual to the new user.

NOTICE

The English text is the original instructions. Other languages are translation of the original instructions.

CONTENTS

	Page	
● Part Names	2	Preparations
• Control panel	2	
● Safety Precautions	3	
● Part Names	6	How to Use
• Screen display	6	
● Basic Operations	8	
● Menu List	10	Setting Change
● Flap Setting for Each Indoor Unit	12	
• FLAP	12	
● Flap Setting for Each Air Outlet	13	
• Lock indiv. flap	13	
● Timer Reservation	14	
• ON/OFF timer	14	
• Weekly timer overview	15	
• Weekly timer	16	
● Filter Information	20	
● Quiet Operation/ Power Consumption Monitor	22	
● Energy Saving	24	
• Temp auto return	24	
• Temp range	25	
• Auto shutoff	26	
• Schedule peak cut	28	
• Repeat off timer	30	
● Outing Function	31	
● Initial Settings	33	
• Clock/Clock type/Operation lock	33	
• Controller name	34	
• Touch sound/Contrast/Backlight/ Language	35	
• Password change/Temp sensor/ Main/sub/Vent output/ Contact address	36	
● Ventilation Setting	38	
● Setting List	39	
● Troubleshooting	41	
● Specifications	42	

Part Names Screen display

Top screen

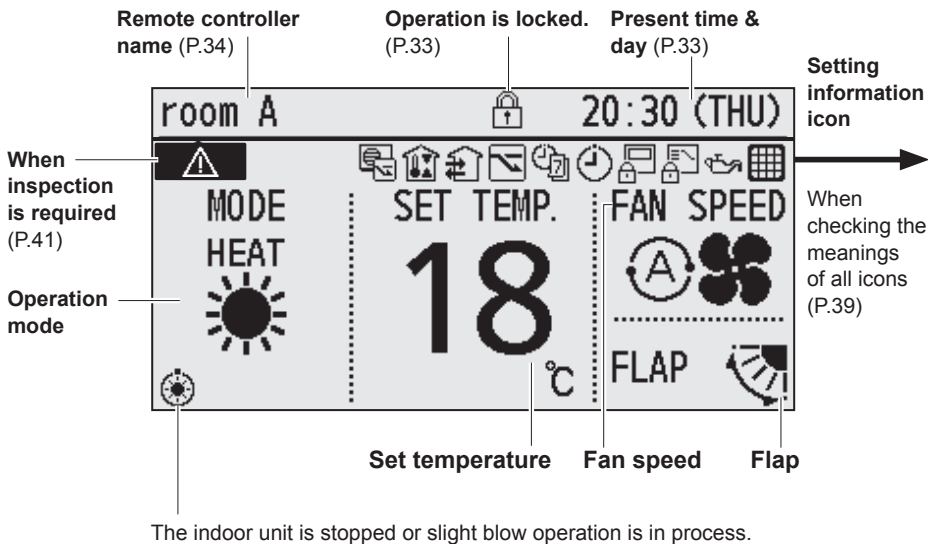

■ Item selection screen

Cursor

■ Operation stop screen









Operation guide (P.7)

■ Lock screen display

[Operation lock] is functioning. (P.33)

- **To cancel lock**
Press button for 4 seconds.

■ Setting information icons displayed on the top screen

Icon	Description	Page
	The indoor unit filter needs to be cleaned.	P.20
	The engine oil needs to be replaced. (Only when using a gas heat pump air conditioner.)	-
	Switching operation modes is prohibited. (Switching to Auto mode is also prohibited.)	-
	Remote control operation is restricted by a central control device.	-
	[ON/OFF timer] is set.	P.14
	[Weekly timer] is set.	P.15
	Energy saving operation is in process.	P.8
	Fresh air is used for ventilation. (Only when connecting a heat exchange ventilation unit or connecting a commercially sold fan.)	P.38
	Prevents the room temperature from increasing too much (or decreasing too much) when no one is in the room.	P.31

Menu screen (P.10)

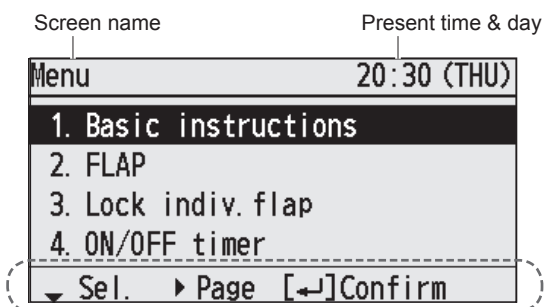

Operation guide The currently operable content is simply displayed.

- ▲▼◀▶: Cross key buttons
- : Enter button

Basic Operations

1 Start operation.

Press .
(The operation indicator illuminates.)

- **To change the setting** (P.10)
- **To turn the energy saving operation ON/OFF**
Press during operation.
(Only for models equipped with the energy saving function.)
- **To stop**
(The operation indicator turns off.)

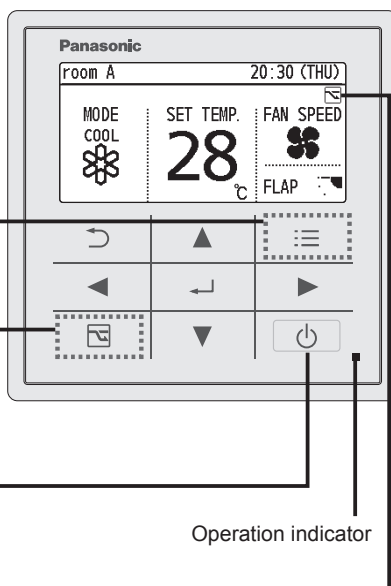





Operation indicator

2 Select the item to set.

Press  .

3 Change the setting.

Press    .

(The cursor disappears.)

Energy saving operation
is in process.

Note

- Operation modes that cannot be set are not displayed.
- The flap display differs from the actual flap angle.
- Pressing  after recovery from mains power failure will resume operation with the contents before mains power failure has occurred.
- If no operation is performed for a certain period of time, the backlight turns off to save electricity. (Press any button for illumination.)
- The energy saving operation restricts the maximum current value, resulting in decreased cooling/heating performance.
(If the current of outdoor units does not reach the peak due to low load operation, the current value is not restricted.)
- The temperature range that can be set varies depending on the model.
- The set temperature range can be changed using the remote controller. (P.24)
- Some models do not display the flap.

Perform the following operations in step 2 on page 8.

■ Operation mode (e.g. Cool, Heat, etc.)

Press ◀.

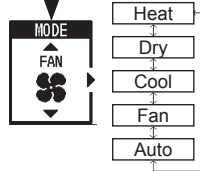
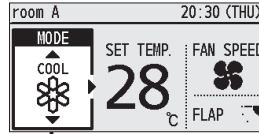

*Auto:
The mode is automatically switched to Cool or Heat to achieve the set temperature.

■ Set temperature

Press ↵. (When the cursor is not visible)

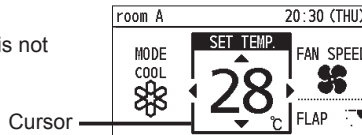

- Cool/Dry: 18 °C to 30 °C
- Heat : 16 °C to 30 °C
- Auto : 17 °C to 27 °C

■ Fan speed

Press ▶.

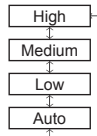
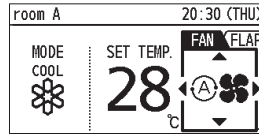

*Auto:
Cannot be selected in Fan mode.

■ Flap

Press ▶ 2 times.

■ Flap Setting for Each Indoor Unit (P.12)

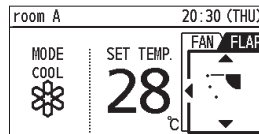

- : Swing
- Pressing ▲▼ during swing can stop the flap at your preferred position.
- 5-level adjustment is possible during Heat, Fan and Auto (Heat) modes.

Menu List

1 Display the menu screen.



■ To return to the previous screen

Press .

■ When no operation is performed in each setting screen for several minutes

The display returns to the top screen.

2 Select the menu item.



■ To turn the page

Press .

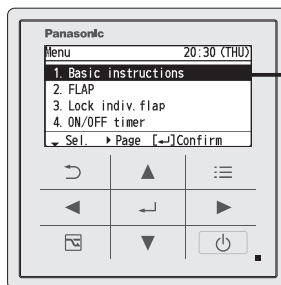

■ Selectable menus (1 to 13)

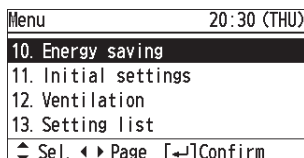
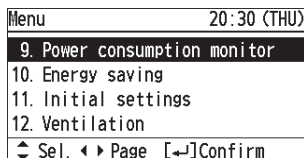
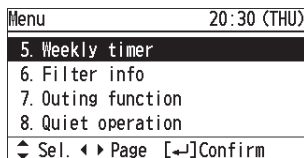
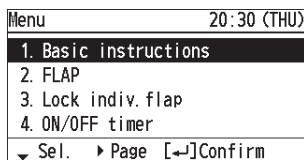

For details of screen examples, see the next page.

■ Menu items (1 to 13)

1	Basic instructions	Explains the basic operations. • Press ◀ ▶ to turn the page.	P.8
2	FLAP*	Sets flaps for each indoor unit.	P.12
3	Lock indiv. flap*	Fixes the flap of a specific air outlet.	P.13
4	ON/OFF timer	Sets the ON/OFF timer	P.14
5	Weekly timer	Sets the operation schedule on a daily basis.	P.15
6	Filter info*	Confirms and resets the time to filter cleaning.	P.20
7	Outing function	Prevents the room temperature from increasing to much (or decreasing too much) when no one is the room.	P.31
8	Quiet operation*☆	Performs quiet operation for outdoor units.	P.22
9	Power consumption monitor*	Confirms the power consumptions on a daily, weekly or yearly basis.	P.23
10	Energy saving	The energy saving functions shown on the right can be set individually aside from the  (Energy saving) button.	
11	Initial settings		
12	Ventilation*	Sets ventilation operation including the heat exchange ventilation unit.	P.38
13	Setting list	Confirms the meanings of setting information icons.	P.39

*Depending on the model, some menus cannot be used. The following display appears.

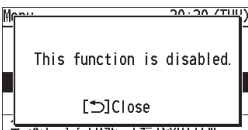

☆The administrator password is required for setting. (P.36)

■ No. 10 [Energy saving] details

Temp auto return	Restores the temperature after the set time has elapsed even if the temperature is changed.	P.24
Temp range	Restricts the temperature range that can be set.	P.25
Auto shutoff	Sets the auto shutoff timer.	P.26
Schedule peak cut☆	Determines the time zone for the energy saving operation.	P.28
Repeat off timer	Stops operation after a certain period of time each time operation is performed.	P.30

■ No. 11 [Initial settings] details

Clock	Sets the present date and time.	P.33
Clock type	Sets the type of clock display.	P.33
Controller name	Names the remote controller.	P.34
Operation lock	Locks the button operations.	P.33
Touch sound	Turns the operation sound ON/OFF.	
Contrast	Sets the screen contrast.	P.35
Backlight	Sets the backlight brightness of the screen.	
Language	Sets the display language for the top screen.	
Password change☆	Sets the administrator password.	P.36
Temp sensor☆	Sets whether to use the temperature sensor of the remote controller or the indoor units.	P.37
Main/sub☆	Set this when 2 remote controllers are connected.	P.37
Vent output☆	Interlocks the ON/OFF of the air conditioner and ON/OFF of the fan.	P.37
Contact address	Confirms the contact address and telephone number for servicing.	P.37

Flap Setting for Each Indoor Unit FLAP

e.g. unit 1-1

e.g. unit 1-3

When setting flaps for each indoor unit

- Flaps of all air outlets of 1 indoor unit face the same direction.



1 Display the menu screen.



■ To return to the previous screen

Press .

■ To return to the top screen

Press 2 times.

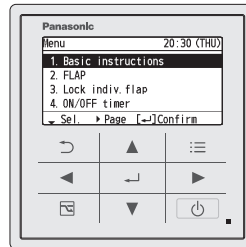

2 Select [FLAP].

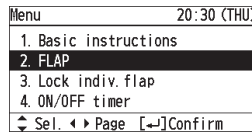

3 Select the indoor unit to set.



- ALL: All units connected to the remote controller

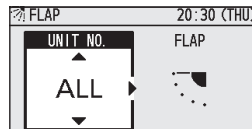

e.g. (unit) ALL → 1-1 → 1-2 to 1-8

4 Select the flap direction.



(Press 2 times to finish.)

- Pressing or during swing can stop the flap at your preferred position.
- Pressing or while swing is stopped sets the flap at the specified position.

When is pressed

When is pressed

- 3-level adjustment is possible for Cool and Dry mode.

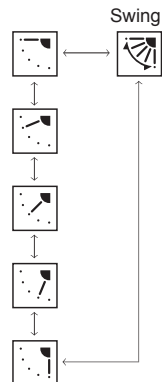
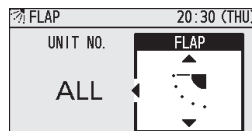

Flap Setting for Each Air Outlet Lock indiv. flap

When setting the flap for each air outlet individually according to the room condition

- Even if the flap setting of all indoor units (P.9) or each indoor unit (P. 12) is changed, the flap directions set here are not changed.

1 Display the menu screen.



■ To return to the previous screen

Press .

■ To return to the top screen

Press 2 times.

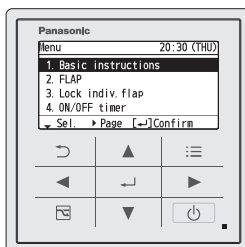

2 Select [Lock indiv. flap]

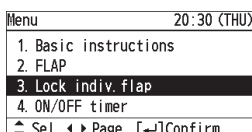

3 Select the indoor unit to set.



e.g. 1-1 → 1-2 to 1-8

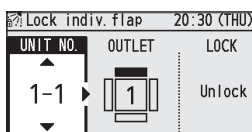

4 Select the air outlet.



- The air outlet No. changes according to the installation direction. Check by actual operation.

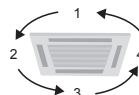
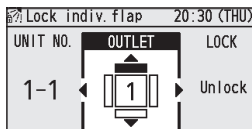

5 Select the flap direction.



(Press 2 times to finish.)

- Although is also displayed in Cool and Dry mode, the actual direction is .

- * For types other than the 4-way cassette type, the following display appears and this function cannot be used.

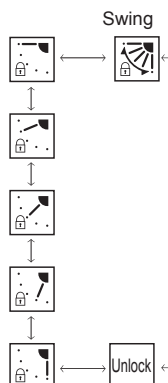
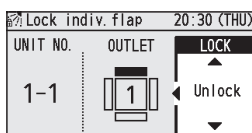
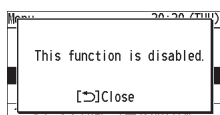

Timer Reservation ON/OFF timer

This turns ON/OFF at the specified time. (e.g. Turning ON/OFF after 3 hours)



- Use OFF timer for example when: Reducing electric consumption while sleeping
- Use ON timer for example when: Operating the air conditioner according to the meeting start timing

1 Display the menu screen.



■ To return to the previous screen

Press

■ To return to the top screen

Press 2 times.

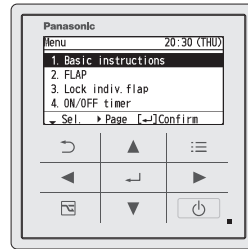

2 Select [ON/OFF timer].

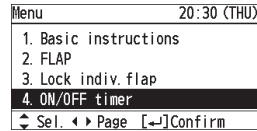

3 Select the timer type



- Select [OFF timer] or [ON timer].

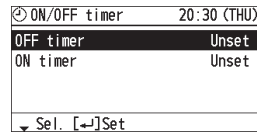

4 Select [Set].



- To set the timer to OFF, select [Unset].

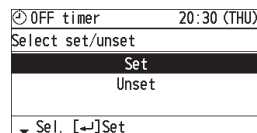

5 Set the time.



(Press 2 times to finish.)

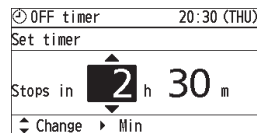

- Upper limit: Stops in 72 h. (by the 30 minutes)

Note

- If ON timer and OFF timer are set to the same time, priority is given to OFF timer, and ON timer cannot be used.

Timer Reservation Weekly timer overview

You can set a weekly operation schedule.

- The operation ON/OFF schedule or temperature setting schedule can be set by setting the day and time (e.g. Setting the operation start time to 8:00 a.m. from every Monday to Friday.).

How to set (Overview)

- Select **"Day"**
- Select **"Time"**
- * Select **"Operation"**
- Select **"Temperature"**
(Only for operations other than ON/OFF)

Weekly timer		20:30 (THU)	
Day	SUN	MON	TUE WED THU FRI SAT
1.	10:00	ON	26°C
2.	17:00	OFF	
3.	--:--	---	--°C
◀ ▶ Day [←] Register			

(See P.16 for setting procedure)

- ***Operation**
- ON**: Starts operation with the temperature set last.
 - OFF**: Stops operation.
 - ON & TEMP**: Starts operation with the specified temperature.
 - TEMP**: Sets the temperature to the specified temperature during operation.

Combination examples

■ 1. Stop operation earlier on "No-overtime work day"

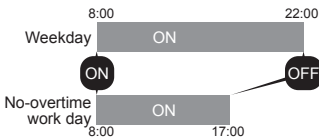

Weekly timer		20:30 (THU)	
Day	SUN	MON	TUE WED THU FRI SAT
1.	8:00	ON	
2.	17:00	OFF	
3.	--:--	---	--°C
◀ ▶ Day [←] Register			

- The setting registered for 1 day can be copied to other days. (P.19)

■ 2. Set the temperature higher after the fixed time.

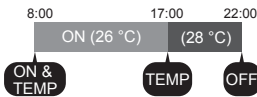

Weekly timer		20:30 (THU)	
Day	SUN	MON	TUE WED THU FRI SAT
1.	8:00	ON	26°C
2.	17:00	OFF	28°C
3.	22:00	OFF	
◀ ▶ Day [←] Register			

■ 3. Stop operation during lunch break.

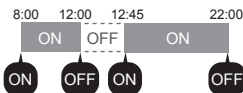

Weekly timer		20:30 (THU)	
Day	SUN	MON	TUE WED THU FRI SAT
1.	8:00	ON	
2.	12:00	OFF	
3.	12:45	ON	
◀ ▶ Day [←] Register			

■ 4. This Thursday is a holiday.

The timer can be disabled only for the specified days with the registered schedules kept. (P.16)

- Disable () the timer of the specific Thursday which falls on a holiday.
- Enable () the timer after the holiday is over.

Weekly timer		20:30 (THU)	
Select enable <input checked="" type="checkbox"/> /disable <input type="checkbox"/>			
	SUN	MON	TUE WED THU FRI SAT
	-	✓	✓ ✓ - ✓ -
◀ ▶ Day ↕ [←] Timer			

Timer Reservation Weekly timer

New registration • e.g. Start operation with 26 °C at 10:00 a.m. on every Sunday.

1 Display the menu screen.



■ To return to the previous screen

Press .

■ To return to the top screen

Press 2 times.

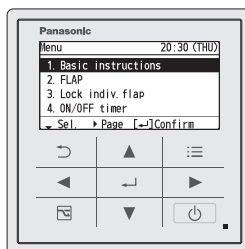

2 Select [Weekly timer].

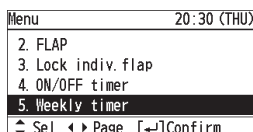

3 Enable the Weekly timer.



- Select the item with and select (enable)/ (disable) with .

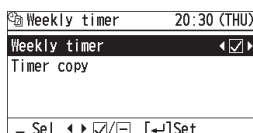

4 Select for all days when the timer is used.



(Repeat)

- Select the days with and select (enable)/ (disable) with .

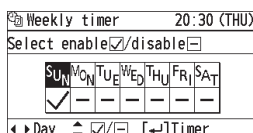

5 Select the day for the timer setting.

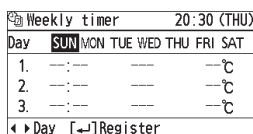

6 Select the field to register the timer setting.



- Up to 8 settings are available for each day.
- After registration, the items are arranged in time series automatically.

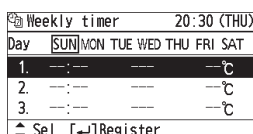

7 Set the start time for the timer operation.

hour minute
 ▲ ▼ → ▶ → ▲ ▼ → ↵

Sunday :No. 1	20:30 (THU)
Set the time	
10 : 00	
Change	Min

• 0:00 to 23:59

8 Select the timer operation.

▲ ▼ → ↵

- Types of timer operation
- **ON:** Starts operation with the temperature set last.
- **OFF:** Stops operation.
- **ON & TEMP.:** Starts operation with the specified temperature.
- **TEMP.:** Sets the temperature to the specified temperature during operation.

Sunday :No. 1	20:30 (THU)
Select timer operation	
ON OFF ON & TEMP.	
Sel. [↵]	Set temp.

9 Set the temperature.

▲ ▼ → ↵

(Only for operations other than ON/OFF)

Sunday :No. 1	20:30 (THU)
Set temperature	
26 °C	
Change [↵]	Confirm

10 Confirm the setting content.

Confirm and press ☰.

(Press 2 times to finish.)

- **To register additionally**
Repeat from step 6 without pressing ☰.
- **To copy the setting content to other days** (P.19)

Weekly timer	20:30 (THU)						
Day	SUN	MON	TUE	WED	THU	FRI	SAT
1.	10:00	ON	26°C				
2.	--:--	--	--°C				
3.	--:--	--	--°C				
Sel. [↵]	Change						

To set the timer to OFF

Starting with step 1, select [-] in step 3 and press ☰ 2 times.

To set the timer to OFF for specified days after registration

(national holidays, etc.)

Starting with step 1, set [-] for OFF days in step 4 and press ☰ 2 times.

Timer Reservation

Weekly timer continued

Change/Delete

1 After steps 1 to 4 on page 16, select the day to change or delete.



Weekly timer		20:30 (THU)	
Day	SUN	MON TUE WED THU FRI SAT	
1.	8:00	ON	26°C
2.	17:00	OFF	
3.	--:--	---	--°C
◀ ▶ Day [↔] Register			

2 Select the schedule to change or delete.



Weekly timer		20:30 (THU)	
Day	SUN	MON TUE WED THU FRI SAT	
1.	8:00	ON	26°C
2.	17:00	OFF	
3.	--:--	---	--°C
⬆ Sel. [↔] Change			

3 Select [Change] or [Delete].



Sunday		20:30 (THU)	
Select change/delete No. 1			
Change			
Delete			
⬇ Sel. [↔] Next			

4 Perform [Change] or [Delete] as follows.

- **To change the setting**, following steps 7 to 10 on page 17, set the time, timer operation and temperature and confirm the content.
- **To delete the setting**, select [YES].



(Press 2 times to finish.)

Sunday		20:30 (THU)	
Delete Sunday No. 1?			
YES ◀ NO			

- To change or delete settings repeatedly: Repeat from step 1 without pressing [☰].

Note

- To delete all schedules of selected days

- 1 Select the day in step 1 above and press [↔].
- 2 Select [Delete all: O] with ▲ ▼ and press [↔].
- 3 Select [YES] with ◀ ▶ and press [↔].

Sunday		20:30 (THU)	
Select change/delete			
Change			
Delete all: SUN			
⬆ Sel. [↔] Next			

Timer Reservation Weekly timer continued

Timer copy

The registered schedule can be copied to other days.
This is convenient to apply the same schedule to multiple days.

1 Display the menu screen.



■ To return to the previous screen

Press .

■ To return to the top screen

Press 2 times.

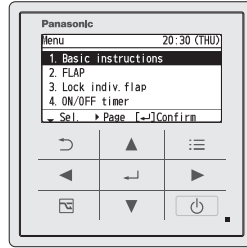

2 Select [Weekly timer].

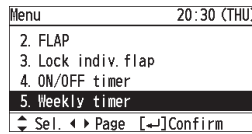

3 Select [Timer copy].

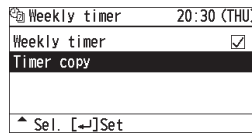

4 Select the copy source day.

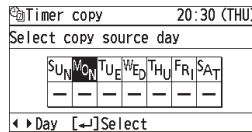

5 Select [✓] for all copy target days.



- Select the days with and select with .

- : Copy source

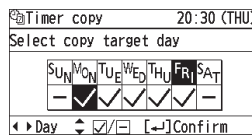

6 Select [YES].



(Press 2 times to finish.)

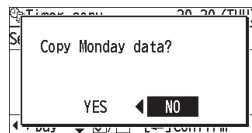

Filter Information

1 Display the menu screen.



■ To return to the previous screen

Press .

■ To return to the top screen

Press 2 times.

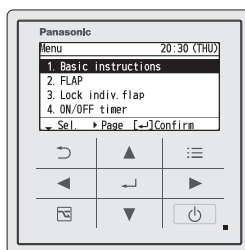

2 Select the item to set.

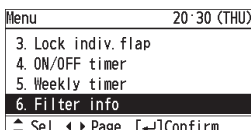

Filter information

3 Select [Next filter cleaning time].

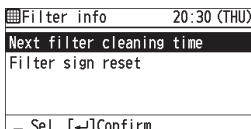

4 Confirm the operation time to the next cleaning.



(Press 2 times to finish.)

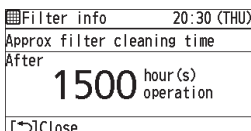

■ When cleaning is immediately necessary

The screen shown on the right is displayed. Clean the filter.

(See operating instructions of the indoor unit.)

■ After the filter is cleaned

Select [Filter sign reset] in step 3 above and select [YES].



(Press 2 times to finish.)

(The filter cleaning time count is reset.)

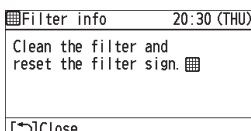

Note

- Depending on the model, [Filter info] cannot be used. In this case, a message is displayed as shown on the right.

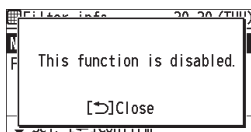

- When the cleaning time comes, the icon shown on the right appears on the top screen.

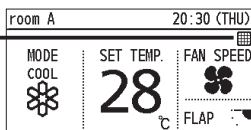

Quiet Operation/Power Consumption Monitor

1 Display the menu screen.



■ To return to the previous screen

Press .

■ To return to the top screen

Press 2 times.

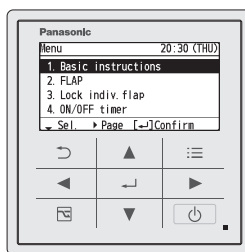

2 Select the item to set.

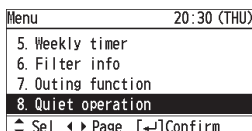

Quiet operation

3 Enter the password.



(Repeat)

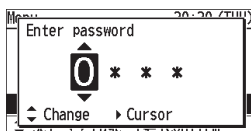

4 Set [Select enable/disable] to .

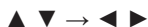

- Select the item with and select / with .

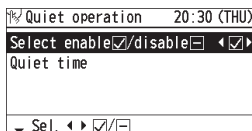

5 Select [Quiet time].

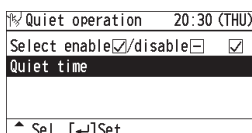

6 Set the time to perform quiet operation.



(Repeat)

(Press 2 times to finish.)

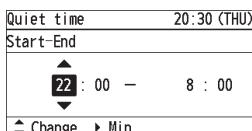

Power consumption monitor

3 Select the period to display.

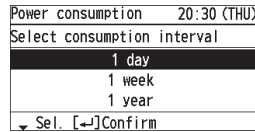

4 Confirm the information.

(Press 2 times to finish.)

- 1 day

Power consumption (approx.)

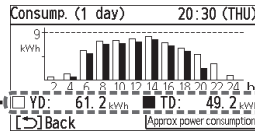

- 1 week

Power consumption (approx.)

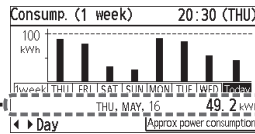

- Pressing can switch data of 1-week total and data of each day.

- 1 year

Power consumption (approx.)

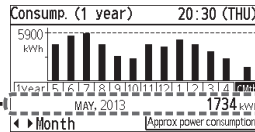

- Pressing can switch data of 1-year total and data of each month.

Note

- Depending on the model, [Quiet operation] and [Power consumption monitor] cannot be used. In this case, a message is displayed as shown on the right.

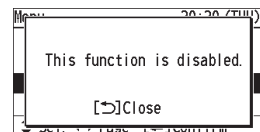

- Using the quiet operation function may deteriorate the performance to reduce the operation sound.
- The power consumption shows an approximate calculation result, which may differ from the measurement result calculated by a power meter.

Energy Saving

■ Temp auto return

Restoring the changed temperature to the originally set temperature automatically after a specified time elapses. (e.g. Only when a guest comes)

■ Temp range

Restricting the temperature range that can be set. (Temperatures outside the range cannot be set.)

1 Display the menu screen.



■ To return to the previous screen

Press

■ To return to the top screen

Press 2 times.

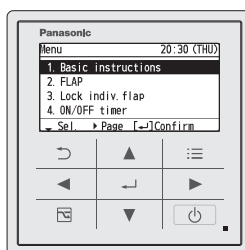

2 Select [Energy saving].

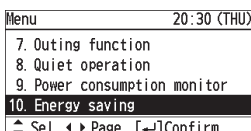

3 Select the item to set.

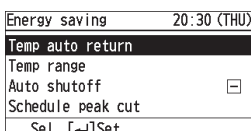

Temp auto return

4 Select the item and set to .



■ To operate only when energy can be saved

Select [Return type] with and select [Saving] with .

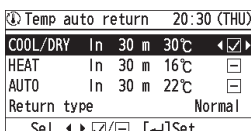

5 Set the time to return to the set temperature.



(10 to 240 min: by the 10 min)

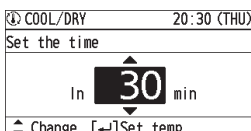

6 Set the temperature.



(Press 2 times to finish.)

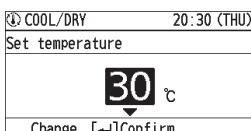

■ To set in series Repeat from step 4 without pressing .

Energy Saving

■ Auto shutoff

When the operation is stopped at a specified time (e.g. closing time) and resumed afterwards, this function detects the operation status at regular time intervals and stops operation automatically.

Detect the operation status at regular time intervals and stop the operation automatically. (e.g. 60 min)

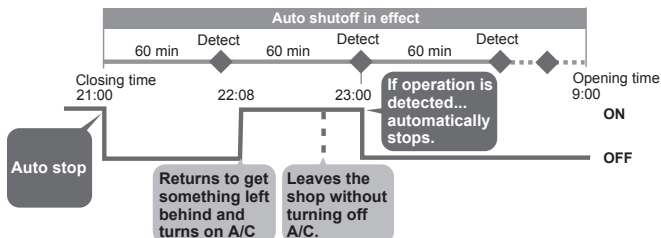

1 Display the menu screen.



■ To return to the previous screen

Press

■ To return to the top screen

Press 2 times.

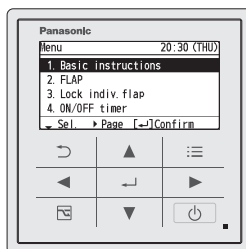

2 Select [Energy saving].

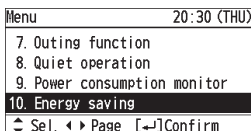

3 Select [Auto shutoff] and set to .

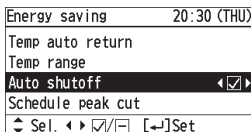

4 Select the item to set.

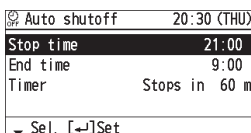

Stop time

Time to stop operation (Time when Auto shutoff is activated)

5

Set.

hour minute
▲ ▼ → ▶ → ▲ ▼ → ◀ → ☰
(Press 2 times to finish.)

Auto shutoff	20:30 (THU)
Set the stop time	
21 : 00	
Change	Min

End time

Time when Auto shutoff stops

5

Set.

hour minute
▲ ▼ → ▶ → ▲ ▼ → ◀ → ☰
(Press 2 times to finish.)

Auto shutoff	20:30 (THU)
Set the end time	
9 : 00	
Change	Min

Timer

Time interval to detect operation status after [Stop time]

5

Set.

▲ ▼ → ◀ → ☰
(Press 2 times to finish.)

Auto shutoff	20:30 (THU)
Set timer	
Stops in 60 min.	
Change	Confirm

- 10 min to 180 min
(by the 10 min)

Energy Saving

■ Schedule peak cut

This reduces the operation capacity for the specified time period.

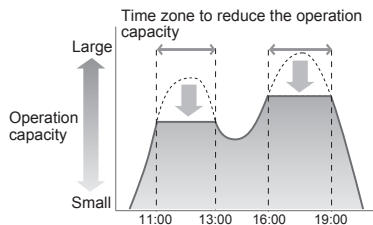

1 Display the menu screen.



■ To return to the last screen

Press .

■ To return to the top screen

Press 2 times.

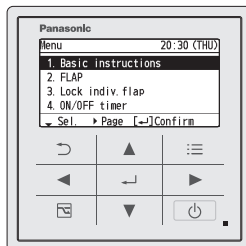

2 Select [Energy saving].

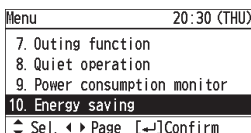

3 Select [Schedule peak cut].

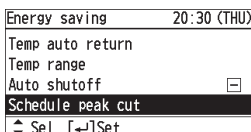

4 Enter the password.

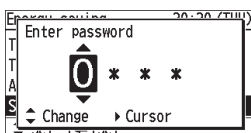

5 Set [Select enable/disable] to .

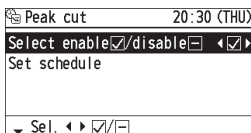
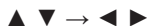

6 Select [Set schedule].

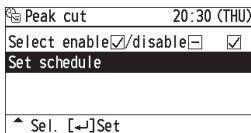

7 Change the setting.

Select the field to register.

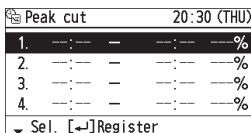

8 Set the start time and end time.

▲ ▼ → ► → ▲ ▼ → ◀
(Repeat)

Peak cut:1	20:30 (THU)
Set the start time	
12 : 00	
Change ▶ Min	

9 Select the operation capacity.

▲ ▼ → ◀ → ☰
(Press 2 times to finish.)

Peak cut:1	20:30 (THU)
Set operation capacity	
80 %	
Change [↔] Confirm	

■ To set in series

Repeat from step 4 without pressing ☰.

■ To change

- Select the field to change in step 7 above.
- Select [Change].
- Following the above steps 8 to 9, select the start time, end time and operation capacity.

Peak cut	20:30 (THU)
1.	12:00 — 16:00 80%
2.	—:— —:— —:—%
3.	—:— —:— —:—%
4.	—:— —:— —:—%
Sel. [↔] Change	

Peak cut:1	20:30 (THU)
Select change/delete No. 1	
Change	
Delete	
Sel. [↔] Next	

■ To delete

- Select the field to delete in step 7 above.
 - Select [Delete].
 - Select [YES].
- ◀ ► → ◀ → ☰
(Press 2 times to finish.)

Peak cut	20:30 (THU)
1.	12:00 — 16:00 80%
2.	—:— —:— —:—%
3.	—:— —:— —:—%
4.	—:— —:— —:—%
Sel. [↔] Change	

Peak cut:1	20:30 (THU)
Select change/delete No. 1	
Change	
Delete	
Sel. [↔] Next	

Peak cut:1	20:30 (THU)
Schedule peak cut: Delete data 1?	
YES	◀ NO

Energy Saving

Repeat off timer

This stops operation after a certain period of time each time operation is performed.

(e.g. When forgetting turning off)

(e.g. Setting to stop operation after 60 minutes)

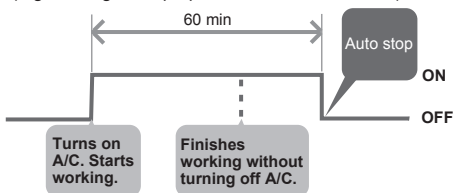

1 Display the menu screen.



To return to the previous screen

Press

To return to the top screen

Press 2 times.

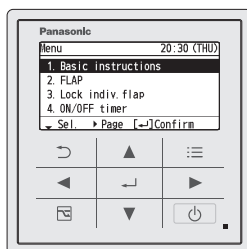

2 Select [Energy saving].

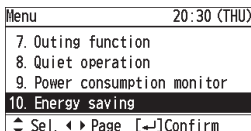

3 Select [Repeat off timer] and set to .

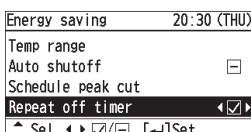

4 Set the timer to stop.



(Press 2 times to finish.)

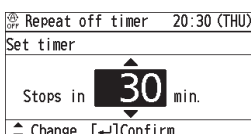

- 10 min to 180 min
(by the 10 min)

Outing Function

This function prevents the room temperature from rising too high (or dropping too low) when no one is in the room due to outing, etc.

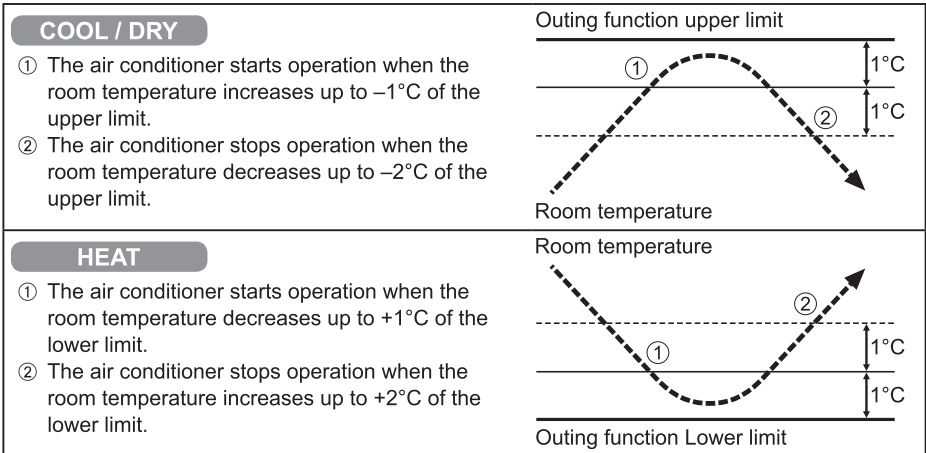

General Performance of the Outing Function



[Precautions]

- The outing control only starts/stops the air conditioner. It does not change the operation mode/temperature setting. Therefore, the operation mode/temperature needs to be set beforehand so that the outing function turns on the air conditioner with your desired operation mode/temperature setting.
 - If the room temperature rapidly changes, the room temperature may get over the upper or lower limit when the outing function is activated.
 - The outing function is invalid during FAN/AUTO operation mode.
 - The air conditioner's stop order (stated in ② / above) is valid only when the outing function is operated.
- If operated using other remote control unit (or a centralized control device such as a system control), the outing function does not work.

• Outing function indication

Outing function indication	Status
Off	The outing function is not set.
Flashing 	The outing function is now being set, or under operation.
Lighting 	Although the outing function is set, not under operation.

Note

A remote controller loses outing function operation information when it is cut for more than Seventy-two hours during the outing function operation by electricity. It reverts from the blackout, and an air conditioner does not drive in outing function when operation is started. At this time, an air conditioner does not stop at outing function.

Outing Function

1 Display the menu screen.



- To return to the previous screen

Press .

- To return to the top screen

Press 2 times.

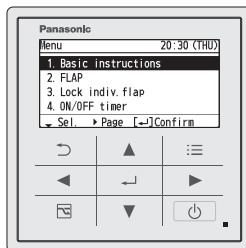

2 Select [Outing function]

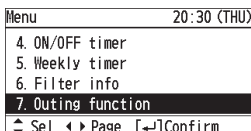

3 Select [Select enable/disable] and set to .

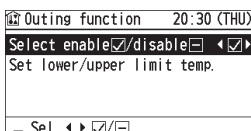

4 Select [Set lower/upper limit temp.].

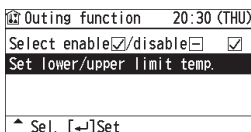

5 Set the temperature range.



(Press 2 times to finish.)

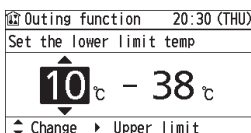

Initial Settings

■ Clock

■ Clock type

■ Operation lock

1 Display the menu screen.



■ To return to the previous screen

Press .

■ To return to the top screen

Press 2 times.

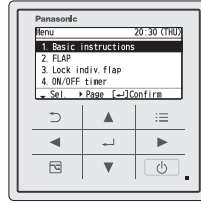

2 Select [Initial settings].



3 Select the item to set.

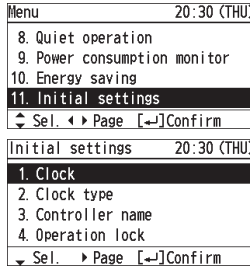

Clock

4 Set the date and time.



(Repeat)

(Press 2 times to finish.)

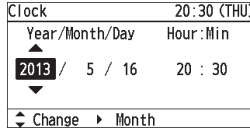

Clock type

4 Select the type to display.



(Press 2 times to finish.)

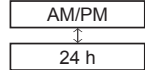
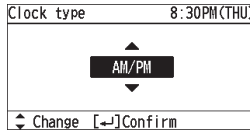

Operation lock

4 Select the type of lock and set to [✓].



(Press 2 times to finish.)

■ To cancel lock

Select [-] in step 4.

■ Only for [Lock all keys]

Select [YES].

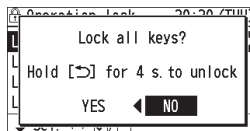
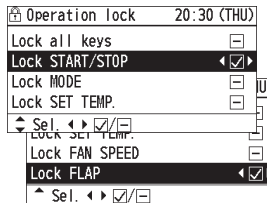

Initial Settings ■ Controller name

The room to which the remote controller belongs can be easily identified.

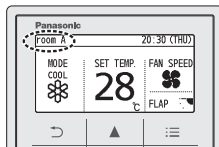

1 Display the menu screen.



■ To return to the previous screen

Press .

■ To return to the top screen

Press 2 times.

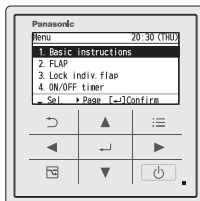

2 Select [Initial settings].

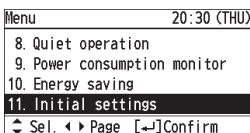

3 Select [Controller name].

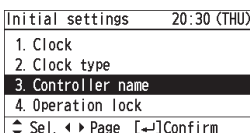

4 Enter the name. (Repeat the same procedure for all characters.)



• Up to 16 characters.

(Space is included in the number of characters.)

■ To change the character type

Select the character type with and press .

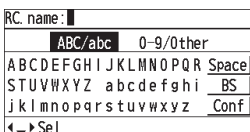

■ To enter space

Select [Space] with and press .

■ To delete 1 character

Select [BS] with and press .

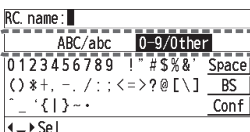

5 Select [Conf].



(Press 2 times to finish.)

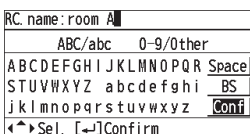

Initial Settings

- Touch sound
- Contrast
- Backlight
- Language

1 Display the menu screen.



- To return to the previous screen

Press

- To return to the top screen

Press 2 times.

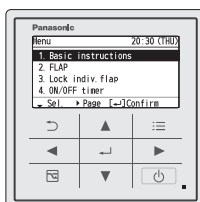

2 Select [Initial settings].



3 Select the item to set.

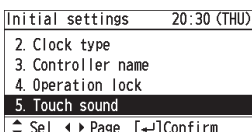
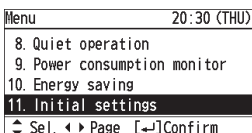

Touch sound

4 (Press 2 times to finish.)

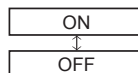
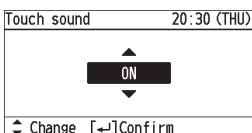

Contrast

4 (Press 2 times to finish.)

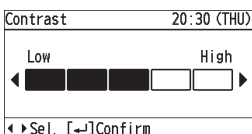

Backlight

4 (Press 2 times to finish.)

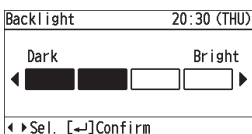

Language

4 (Press 2 times to finish.)

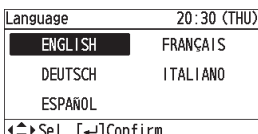

Initial Settings

- Password change
- Temp sensor
- Main/sub
- Vent output
- Contact address

1 Display the menu screen.



- To return to the previous screen

Press .

- To return to the top screen

Press 2 times.

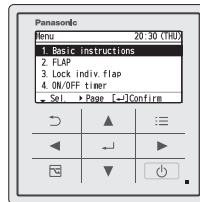

2 Select [Initial settings].



3 Select the item to set.



4 Enter the password as necessary.



(Repeat)

- Select the number with and move to the next field with .

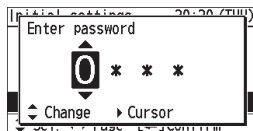
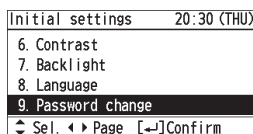
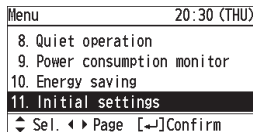

Password change

5 Enter a new password.



(Repeat)

6 Enter the password again to confirm.



(Press 2 times to finish.)

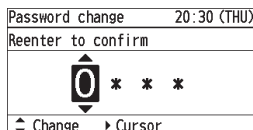
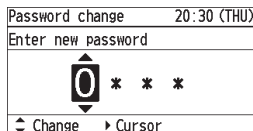

*To display each item, see steps 1 to 4 on the previous page.

Temp sensor

- Select the temperature sensor to control the room temperature.

Temp sensor	20:30 (THU)
Select room temp. sensor	
▲ Remote controller ▼	
◀ Change [↵] Confirm	

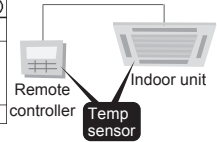

Main/sub

- When 2 remote controllers are connected to the same indoor unit, this registers one remote controller as [Main] and the other as [Sub]. (There is no difference in function between Main and Sub, however, when the remote controller sensor is selected for the temperature sensor setting, the [Main] sensor controls the operation.)

Main/sub	20:30 (THU)
Remote controller	
▲ Sub ▼	
◀ Change [↵] Confirm	

Vent output

- [Set]: When the air conditioner is turned ON/OFF, the connected ventilation fan is turned ON/OFF, too.
- To interlock the air conditioner and the fan, another installation work is required.

Vent output	20:30 (THU)
▲ Set ▼	
◀ Change [↵] Confirm	

Contact address

- If you need to contact for servicing, check the back cover of the operating instructions for indoor units or outdoor units.

Contact address	20:30 (THU)
Name	<input type="text" value="Unset"/>
Contact number	<input type="text" value="Unset"/>
[↵] Close	

Ventilation Setting

1 Display the menu screen.



- To return to the previous screen

Press .

- To return to the top screen

Press 2 times.

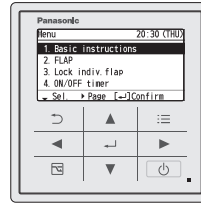

2 Select [Ventilation].

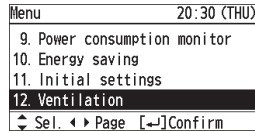

3 Select [Ventilation ON/OFF].

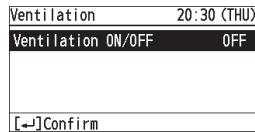

4 Select [ON] or [OFF]



(Press 2 times to finish.)

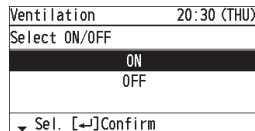

Setting List

This provides the meanings of setting information icons.

1 Display the menu screen.



■ To return to the previous screen

Press .

■ To return to the top screen

Press 2 times.

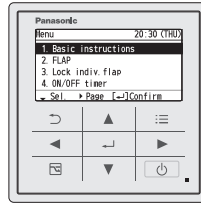

2 Select [Setting list].

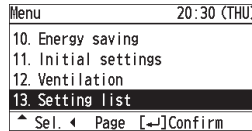

3 Select the item.



- Only icons currently being displayed on the screen are displayed here.

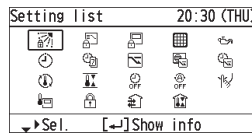







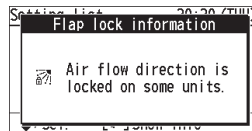











4 Confirm.

Confirm, then →

(Press 2 times to finish.)



■ Setting information icon list

Icon	Description	Page
	[Lock indiv. flap] is set.	P.13
	Switching between Heat and Cool/Dry mode is prohibited (Switching to Auto mode is also prohibited.).	–
	Remote control operation is restricted by a central control device.	–
	The indoor unit filter needs to be cleaned.	P.20
	The engine oil needs to be replaced (only when the gas heat pump air conditioner is used).	–
	[ON/OFF timer] is set.	P.14
	[Weekly timer] is set.	P.15
	Energy saving operation is in process.	P.8
	The operation capacity of the outdoor unit is restricted.	–
	[Schedule peak cut] is set.	P.28
	[Temp auto return] is set.	P.24
	[Temp range] is set.	P.25
	[Auto shutoff] is set.	P.26
	[Repeat off timer] is set.	P.30
	[Quiet operation] is set.	P.22
	The temperature sensor of the remote controller is detecting the room temperature.	P.37
	[Operation lock] is set.	P.33
	Fresh air is used for ventilation. (Only when connecting a heat exchange ventilation unit or connecting a commercially sold fan)	P.38
	[Outing function] is set.	P.31

Troubleshooting

If operation does not start by pressing ...

Check the following before asking for repair.

When the [Centrally controlled] message is displayed

- Being centrally controlled, operation is not possible.

Blackout?

- After recovery from blackout, press  again.
→ If operation does not start, turn off the circuit breaker and consult the dealer of purchase about the symptom and Model No.

Is the circuit breaker turned off?

- Turn it on and press  again.
→ If operation does not start, turn off the circuit breaker and consult the dealer of purchase about the symptom and Model No.

Is [Assigning] blinking?

- After blinking stops, press  again.
→ If operation does not start, turn off the circuit breaker and consult the dealer of purchase about the symptom and Model No.

Is  displayed?

Alarm indication (e.g.)

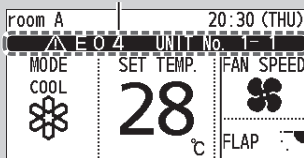

Defective indoor unit No.

- If any of the following alarm indications appears, stop operation once and restart approx. 1 minute later.
(Alarm indication, off)
[•E04 •E06 •P10 •P20 •H06]
→ If the indication does not reappear, use the unit.
→ If the indication reappears or an alarm indication other than the above (combination of numbers and characters such as E, F, H, L and P) appears, stop operation, turn off the circuit breaker and consult the dealer of purchase about alarm indication, Model No. and indoor unit No.

**Cannot stop the operation.
Or the unit starts to run automatically even if  (Off) button is pressed.**

- Check if the outing function is activated or not.

- Check control by central control device.

• If you need to contact for servicing, check the back cover of the operating instructions for indoor units or outdoor units.

Specifications

Model No.	CZ-RTC3	
Dimensions	(H) 120 mm x (W) 120 mm x (D) 16 mm	
Weight	180 g	
Temperature/ Humidity range	0 °C to 40 °C / 20 % to 80 % (No condensation) *Indoor use only.	
Power Source	DC16 V (supplied from indoor unit)	
Clock	Precision	± 30 seconds/month (at normal temperature 25 °C) *Adjust periodically.
	Holding time	72 hours (When fully charged) *Approx. 8 hours are required for full charge.
Number of connected indoor units	Up to 8 units	