

Product Description

LF-GSD060YC series is a 60W constant current LED driver. It has DALI dimming and PUSH dimming functions. The input voltage range is 198-264Vac. The output current can be adjusted via the DIP switch from 1100mA to 1500mA, in steps of 50mA.

Features

- IP20
- Plastic casing
- Suitable for Class I & II light fixtures
- Constant current output and the output current can be adjusted via the DIP switch
- Built-in active PFC function
- Standby power consumption <0.5W
- 0.1% dimming depth
- 10pcs of LED drivers can be dimmed synchronously
- Supports 0-10V/PWM/Rx dimming
- Supports DALI dimming and the logarithmic or the linear dimming curves can be selected via the software
- Supports PUSH dimming
- 7-year warranty (Please refer to the warranty condition.)

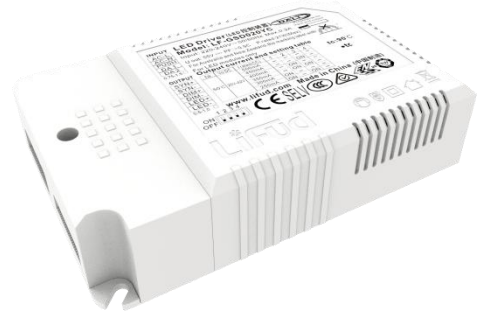

Applications

- Horticultural lighting
- Indoor office lighting
- Decorative lighting
- Commercial lighting
- Residential lighting



Product Naming

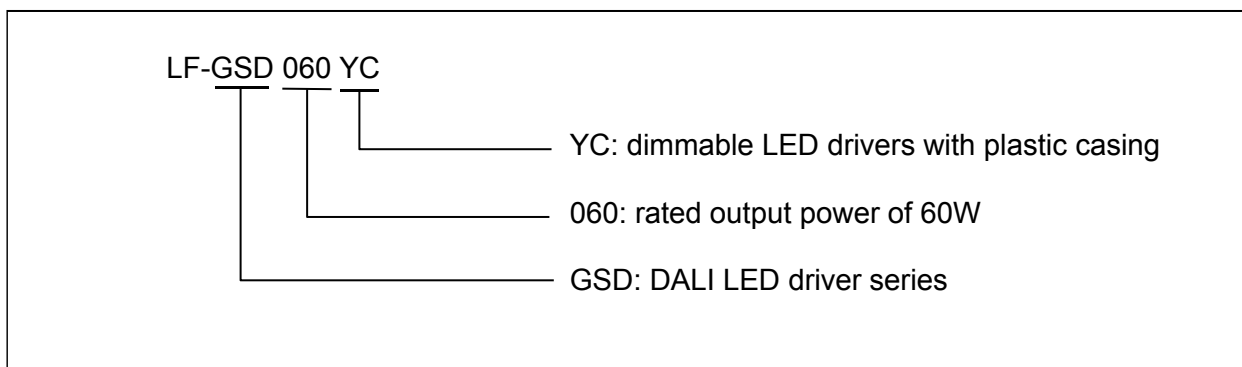

Electrical Characteristics

Model		LF-GSD060YC (0.1% dimming depth)								
Output	Output Voltage	25-42V								
	Output Current	The output current can be adjusted via the DIP switch. Please refer to the DIP switch table.								
		1100 mA	1150 mA	1200 mA	1250 mA	1300 mA	1350 mA	1400 mA	1450 mA	1500 mA
	Flicker Index	IEC-Pst \leq 1%, CIE SVM \leq 0.4%, Modulation Depth \leq 1% Conforms to the flicker free standard (IEEE Std 1789-2015)								
	Ripple Current	<5% (rated current)								
	Current Tolerance	\pm 5%								
	Temperature Drift	\pm 10%								
	Start-up Time	<1.4S@230Vac								
Input	Input Voltage	220-240Vac (voltage limit: 198-264Vac)								
	DC Input Voltage	310-340Vdc (voltage limit: 280-374Vdc)								
	Input Frequency	47-63Hz								
	Input Current	0.5A Max								
	Power Factor	\geq 0.94				\geq 0.95				
	THD	\leq 15%								
	Efficiency	\geq 88%								
	Inrush Current	\leq 60A&350uS@230Vac								
	Load Quantity Carried by the Circuit Breaker	Circuit Breaker Model	B10	C10	B16	C16				
		Quantity (pcs)	13	13	21	21				
	Surge Protection	L-N: 1KV								
	Leakage Current	\leq 0.7mA								
	Stand-by Power Consumption	\leq 0.5W (when the DALI OFF signal is effective)								
Protective Features	Open-Circuit Protection	<55V								
	Short-Circuit Protection	Hiccup mode (auto-recovery)								
Environment Conditions	Operating Temperature	-30°C ~ +50°C								
	Operating Humidity	20-90%RH (no condensation)								
	Storage Temperature/Humidity	-30°C ~ 80°C (six months under class I environment); 10-90%RH (no condensation)								
	Atmospheric Pressure	86-106KPa								

Safety & Electromagnetic Compatibility	Certifications	TUV-ENEC, CCC, RCM, CE, CB
	Withstanding Voltage	I/P-O/P (LED): 3.75KVac 5mA 60S
	Insulation Resistance	I/P-O/P: >100MΩ@500Vdc
	Safety Standards	ENEC: EN61347-1: 2015, EN 61347-2-13: 2014/A1: 2017, EN 62384: 2016/A1: 2009; CE-LVD: EN 61347-2-13: 2014/A1: 2017, EN 61347-1: 2015, EN 62493: 2015; RCM: AS 61347.2-13: 2018; CB: IEC 61347-1: 2015, IEC61347-2-3: 2014, IEC 61347-2-13: 2014/AMD1: 2016; CCC: GB19510.1-2009, GB19510.14-2009
	EMI	CE-EMC/RCM: EN55015, EN61000-3-2, EN61000-3-3 CCC:GB/T17743, GB17625.1, GB17625.2
	EMS	CE-EMC/RCM: EN61000-4-2, 3, 4, 5 (lightning strike 1KV), 6, 11 CCC: GB/T17626.2, 3, 4, 5 (lightning strike 1KV), 6, 11
Others	IP Rating	IP20
	RoHS	RoHS 2.0 (EU) 2015/863
	Warranty Condition	7 yrs (TC≤83℃)
	DALI Standard	IEC 62386-101 102 207: DALI 2.0
Remarks	<p>1. It is recommended that customer should install overvoltage and undervoltage protection devices and surge protection devices in the power supply circuits of the light fixtures to ensure safety before connecting to electricity.</p> <p>2. Please disconnect the AC input before adjusting the output current via the DIP switch.</p> <p>3. The PC cover, casing, end caps and other parts of the LED driver inside the LED light fixture must conform to UL94-V0 flammability standard or above.</p> <p>4. As an accessory, the LED driver is not the only factor determining the EMC performance of the LED light fixture. The structure and the wiring of the light fixture are also relevant. Thus it's strongly recommended the LED light fixture manufacturer should re-confirm the EMC of the whole LED light fixture.</p> <p>5. Unless otherwise stated, the parameters above are test results under these conditions: ambient temperature 25℃, humidity 50%, input voltage 230Vac and 100% load.</p>	

Product Characteristic Curves

■ **PF Curves**

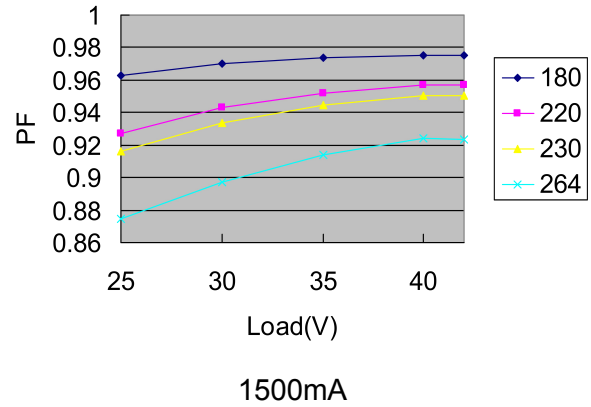
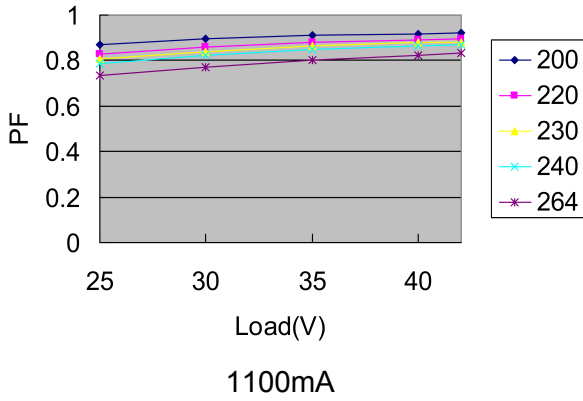

■ **Efficiency Curves**

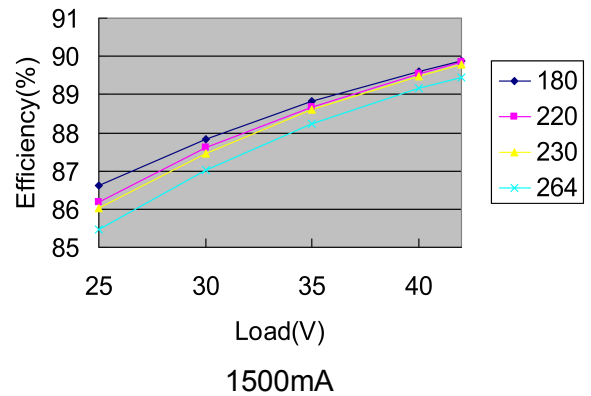
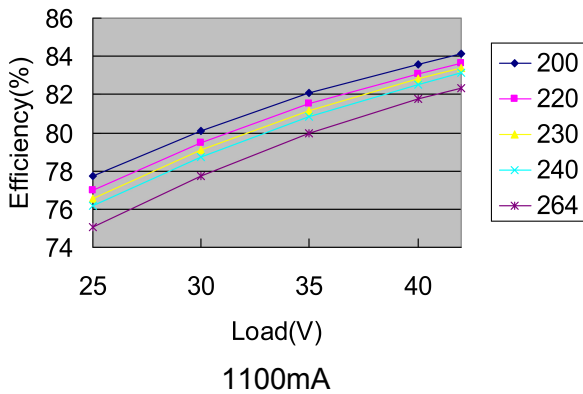

■ **Lifetime Curve**

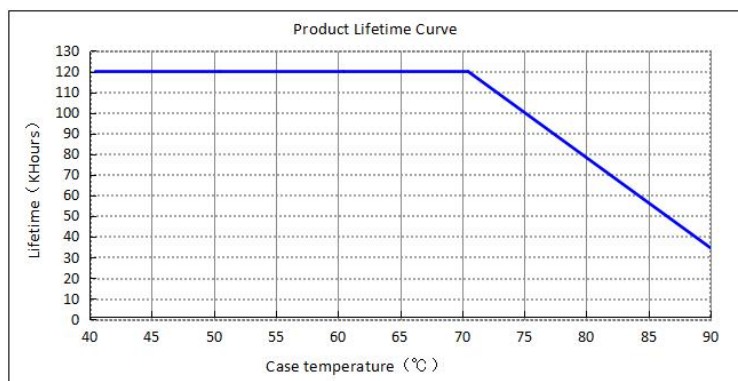

Instructions of Dimming Operation

■ Definition of Driver's Terminals

INPUT

AC-L	Input terminal of AC live wire
AC-N	Input terminal of AC neutral wire
PUSH	Input terminal of PUSH dimming
DA1	Input terminal of DALI1 dimming
DA2	Input terminal of DALI2 dimming

OUTPUT

SYN+	Positive electrode output of synchronous dimming
SYN-	Negative electrode output of synchronous dimming
DIM+	Positive electrode of dimming
DIM-	Negative electrode of dimming
LED+	Positive electrode output of the driver
LED-	Negative electrode output of the driver

■ DIP Switch Table

I rated (CC)	1	2	3	4	5
1500mA	—	—	—	—	—
1450mA	—	—	—	ON	—
1400mA	—	—	ON	—	—
1350mA	—	—	ON	ON	—
1300mA	—	ON	—	—	—
1250mA	—	ON	—	ON	—
1200mA	—	ON	ON	—	—
1150mA	—	ON	ON	ON	—
1100mA	ON	—	—	—	—

Remark: Except the settings mentioned in the table above, other DIP switch settings are default to be the maximum current 1500mA.

■ Wiring Diagram of PUSH Dimming

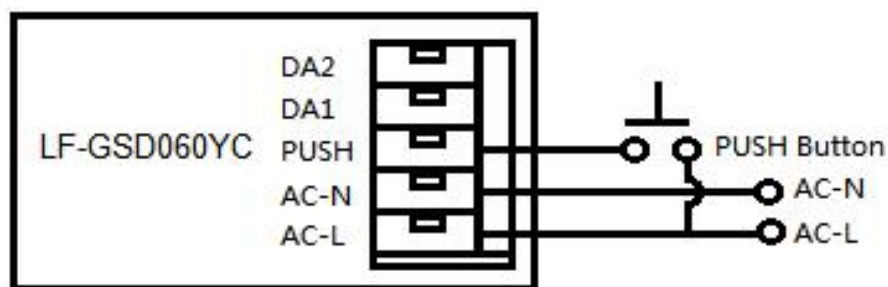

■ Instruction of PUSH dimming

Operation	Operation Time	Function
Instant Push	0.1 ~ 0.5S	Light on / off
Long Push	0.6 ~ 11S	Dim up / down
Reset Push	> 11S	Reset to the 100% brightness

- The PUSH operation won't cause any variation if it's less than 0.1S

- When controlling via the same button, in 0-10V mode, up to 10 pcs of LED drivers can be connected in parallel. In DALI & PUSH mode, up to 640 pcs of LED drivers can be connected in parallel by SYNC DIM connection.
- The PUSH button can only be connected to the middle of AC-L and PUSH terminals. Connecting to AC-N will cause the failure of PUSH dimming function.
- The minimum dimming depth of PUSH dimming is 1% (lout).
- The PUSH dimming mode has the memory function in case of any power failure. When the LED driver is restored, the light will return to the exact status before power failure.
- The maximum length of the leading wire from the PUSH button to the farthest LED driver is 135 meters. The wire diameter range is 16-22AWG.

■ Instruction of DALI dimming

- Factory default setting is of 100% brightness.
- Connect the DALI signal to DA1 and DA2 terminals.
- DALI protocol includes 16 groups and 64 IP addresses.
- The minimum dimming depth of DALI dimming is 0.1% (lout).

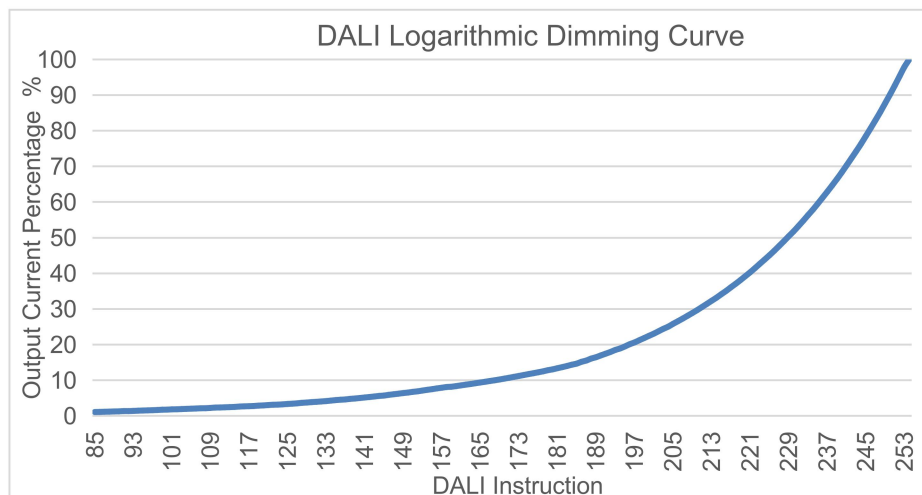

■ Instruction of 0-10V/PWM/Rx dimming

- 0-10V, PWM and Rx signals should be connected to the DIM terminal.
- In 0-10V mode, the light turns off when the input voltage $\leq 0.3V$ and turns on when the input voltage $\geq 0.5V$.
- The minimum dimming depth of 0-10V dimming is 5% (lout).

0-10V dimming

Dimming voltage	≤0.3V	1V	2V	3V	4V	5V	6V	7V	8V	9V	10V
Rated current percentage	OFF	5%	20%	30%	45%	55%	70%	80%	90%	100%	100%

PWM dimming

PWM signal	0%	10%	20%	30%	40%	50%	60%	70%	80%	90%	100%
Rated current percentage	OFF	15%	35%	50%	65%	75%	90%	95%	100%	100%	100%

Rx dimming

Resistance	0K	10K	20K	30K	40K	50K	60K	70K	80K	90K	100K
Rated current percentage	OFF	25%	50%	60%	70%	80%	85%	90%	95%	100%	100%

Remark: Factory default setting is of 100% brightness.

■ **Instruction of Synchronous dimming**

- The maximum number of LED drivers can be dimmed synchronously is 10 pcs (one master and nine slaves). The maximum wire length between two LED drivers is 15 meters. The maximum wire length between the master and the farthest slave is 135 meters. The wire diameter range is 16-22AWG.
- The method of switching to synchronous dimming: choose a driver as a master and switch the fifth gear on the DIP switch to ON.
- The master can directly control slaves via DALI, 0-10V and push dimming signals to realize synchronous dimming function.
- Wiring diagram of synchronous dimming:

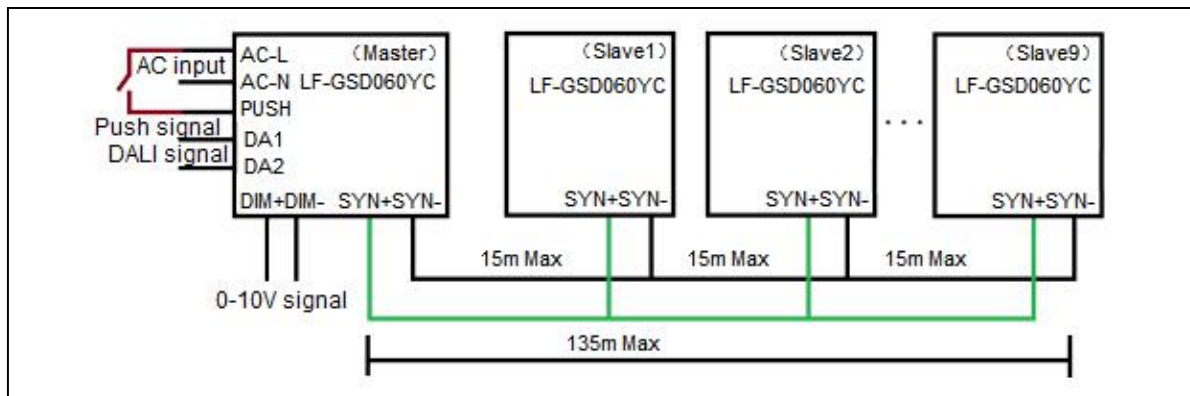

- Before using synchronous dimming function, please make sure that all LED drivers are at 100% output.

- When the synchronous dimming signal is withdrawn from the slaves, the slaves enter DALI mode by default.

■ **Switch between dimming modes**

● **Switch to DALI dimming**

After powering on the driver for two seconds, press the DALI dimmer for ON/OFF operation. And then it becomes DALI dimming mode.

● **Switch to PUSH dimming**

After powering on the driver for two seconds, press the PUSH switch for at least three seconds. And then it becomes PUSH dimming mode.

● **Switch to 0-10V dimming**

After powering on the driver for two seconds, adjust the 0-10V dimmer to the brightest or to the dimmest. One second later, it becomes 0-10V dimming mode.

Remark: When switching the DALI mode to another mode, the light must be on. It's a default setting that when the light is off because the DALI dimming mode cannot be switched to another mode.

Label

LED Driver (LED 控制装置)

Model: LF-GSD060YC

Input: 220-240V~50/60Hz Max.0.5A
Uout: 55V PF:≥0.9C P rated:63W(Max)
For LED modules only
For Australia and New Zealand, the marking label with*

DALI 2
Preparation for input and output
7.5mm

Ia	Vo DC	I rated(CC)	1	2	3	4	5
1500mA			-	-	-	-	-
1450mA			-	-	-	ON	-
1400mA			-	-	ON	-	-
1350mA			-	-	ON	ON	-
1300mA			-	ON	-	-	-
1250mA			-	ON	-	ON	-
1200mA			-	ON	ON	-	-
1150mA			-	ON	ON	ON	-
1100mA			ON	-	-	-	-

50°C 25V-42V

Dimmable
0.1%-100%
tc:90°C
www.lifud.com
Made in China
(中国制造)

ON OFF 1 2 3 4 5

CE SELV CCC TUV

Dimensions (unit: mm)

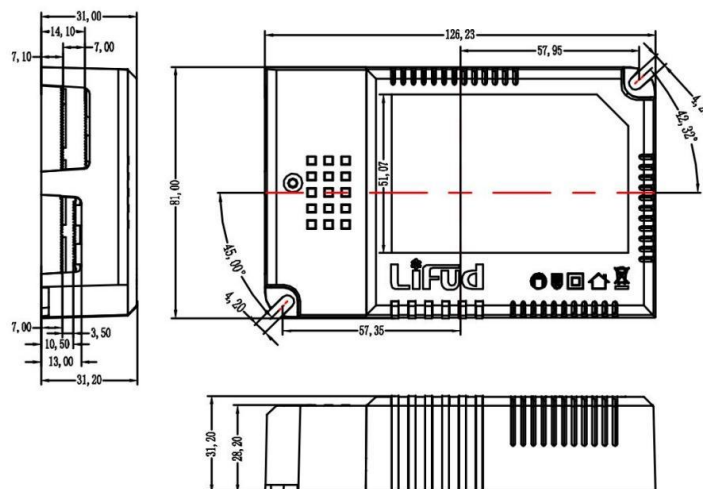

Packaging Specifications

Model	LF-GSD060YC
Packaging Dimension	385×285×210mm (L×W×H)
Quantity	8 pcs/layer; 6 layers/ctn; 48 pcs/ctn
Weight	0.2192 kg/pc; 11.67 kg/ctn

Transportation & Storage

■ Transportation

- Suitable transportation means: vehicles, boats and aircraft.
- During transportation, there should be awnings for rain protection and sun protection. Civilized loading and unloading are required. There should be no severe vibration or impact.

■ Storage

- Storage in accordance with the provisions of the Class I environment. For products which have been stored for more than six months, they mustn't be used until they pass the re-inspection.

Attention

- Please use this product according to its specifications otherwise there may be malfunction.
- Use light fixtures that have not been certified or are not compatible with the LED drivers may cause fire or other hazards.
- Man-made damage, any use beyond the specification and non-original-factory modification are not covered by warranty.

Remark: The final interpretation right of the contents of this data sheet belongs to Lifud Technology Co., Ltd.